

**SKITRAB**

SKITRAB.COM



**MADE IN BORMIO SINCE 1946**  
**COLLECTION 2023/2024**







## 2023/2024 PRODUCT CATALOGUE

---

<b>MADE IN BORMIO</b>	4
<b>TECHNOLOGIES</b>	6
<b>INNOVATION</b>	8
<b>SKI</b>	12
GARA SKIS TOURING SKIS FREETOURING SKIS	
<b>BINDINGS</b>	48
GARA BINDING TOURING BINDING	
<b>SKINS</b>	64
<b>POLES</b>	67
1 PIECE LIGHT POLES / 1 PIECE TOURING POLES 2 PIECES TOURING POLES 3 PIECES TOURING POLES	
<b>GLOVES</b>	74
GARA LINE EXPERT LINE COMFORT LINE	
<b>HELMETS/GOGGLES</b>	84
<b>BACKPACK/BAGS</b>	92
<b>BEANIES/BANDS</b>	102
<b>CLOTHES</b>	111
<b>PROMO TOOLS</b>	117



**MADE IN BORMIO**  
SINCE 1946





## **TRADITION** **MADE IN BORMIO SINCE 1946**

### **A STORY OF CULTURE AND PASSION OF SKI TOURING**

INNOVATING, DESIGNING AND MANUFACTURING OUR PRODUCTS WHERE THEY CAN BE TESTED AND USED.

COLLABORATING WITH THE BEST MOUNTAIN PROFESSIONALS - WHO ARE PASSIONATE ABOUT WHAT THEY DO, AND HAVE CHOSEN TO DO IT HERE.

COLLABORATING WITH THE BEST ATHLETES - WHO WERE EITHER BORN HERE OR ARE HEADED HERE THANKS IN PART TO THE 2026 WINTER OLYMPICS.

KEEPING TRADITIONAL ARTISANAL TECHNIQUES ALIVE, SUPPORTING THEM WITH MORE MODERN, ADVANCED TECHNOLOGY.

HAVING COMPLETE CONTROL OF PRODUCTION AND DESIGN.

RESPECTING DELICATE ALPINE ECOSYSTEMS BY SELECTING EVER MORE SUSTAINABLE MATERIALS AND USING RENEWABLE ENERGY.

*IMMAGINARE, PROGETTARE E COSTRUIRE I NOSTRI PRODOTTI DOVE POSSONO ESSERE TESTATI ED UTILIZZATI.*

*COLLABORARE CON I MIGLIORI PROFESSIONISTI DELLA MONTAGNA CHE QUI HANNO DECISO DI ESERCITARE LA LORO PASSIONE.*

*COLLABORARE CON I MIGLIORI ATLETI CHE QUI SONO NATI O CONVERGONO GRAZIE ANCHE ALLA FUTURA PRESENZA DELLE OLIMPIADI.*

*MANTENERE VIVA LA TRADIZIONE ARTIGIANALE, SUPPORTANDOLA CON LE TECNOLOGIE PIÙ MODERNE ED AVANZATE.*

*AVERE IL COMPLETO CONTROLLO SULLA PRODUZIONE E PROGETTAZIONE.*

*RISPETTARE I DELICATI ECOSISTEMI ALPINI TRAMITE LA SCELTA DI MATERIALI SEMPRE PIÙ SOSTENIBILI E L'UTILIZZO DI ENERGIE RINNOVABILI.*

COPERTURA DI PROTEZIONE ANTIGRAFFIO IN PA  
SCRATCH PROOF PA PROTECTION SHELL

CAP IN TESSUTO CARBONIO BIASSIALE  
BIAXIAL CARBON FABRIC CAP

LAMINATO IN FIBRA DI CARBONIO BIASSIALE  
BIAXIAL CARBON FIBER LAMINATE

RINFORZO ATTACCO - BASE ANTITORSIONE  
BINDING REINFORCEMENT - ANTITORSIONAL BASE

FIANCO IN LEGNO  
WOODEN SIDEWALL

RINFORZO IN FIBRA DI BASALTO  
BASALT FIBER REINFORCEMENT

SUPPORTO IN FIBRA DI VETRO  
FIBREGLASS SUPPORT

CAP IN TESSUTO VETRO  
GLASS FABRIC CAP

TUBOLARE IN CARBONIO  
CARBON TUBULAR

NIDO D'APE NOMEK  
NOMEK HONEYCOMB

SUPPORTO ANIMA  
CORE SUPPORT

ELASTOMERO  
ELASTOMER

LAMINA ACCIAIO HRC 50 +/-2  
STEEL EDGE HRC 50 +/-2

SUOLA UHMW POLIETILENE ALTA DENSITÀ  
HIGH-DENSITY POLYETHYLENE UHMW BASE





# LAYER CONTROL

# 14

## QUALITY ON THE SNOW 14 LAYER TECHNOLOGY

### QUALITY / DURABILITY / RELIABILITY

WE HAVE DEVELOPED A LIGHTWEIGHT TECHNOLOGY WITH 14 DIFFERENT LAYERS ALLOWING US TO MODEL THE STRUCTURE OF THE SKIS WITH NO HALF-MEASURES.

THIS TECHNOLOGY STANDS OUT FOR COMBINING AN EXTREMELY LIGHT CORE WITH MAXIMUM ANTI-TORSIONAL STRENGTH. 14 DIFFERENT LAYERS WRAP AROUND AN ULTRALIGHT CORE IN ORDER TO REACH THE DESIRED FLEX VALUES WITHOUT COMPROMISING THE STABILITY, TORSIONAL FLEXIBILITY AND DURABILITY PARAMETERS OF THE SKIS IN ANY WAY.

*ABBIAMO SVILUPPATO UNA TECNOLOGIA DEL LEGGERO CON 14 DIFFERENTI STRATI CHE CI PERMETTONO DI MODELARE LA STRUTTURA DELLO SCI SENZA SCENDERE A COMPROMESSI DI ALCUN GENERE.*

*QUESTA TECNOLOGIA SI CARATTERIZZA PER AVER INDIVIDUATO UN PROCESSO PRODUTTIVO CAPACE DI UTILIZZARE UN'ANIMA LEGGERISSIMA E ALLO STESSO TEMPO IN GRADO DI DARE LA MASSIMA FORZA ANTITORSIONALE ALLO SCI.*

*14 DIFFERENTI STRATI AD AVVOLGERE UN'ANIMA ULTRALEGGERA, IN MANIERA TALE DA POTER RAGGIUNGERE VALORI DI FLEX DESIDERATI SENZA IN ALCUN MODO COMPROMETTERE I PARAMETRI DI STABILITÀ, FLESSIBILITÀ TORSIONALE E DURABILITÀ DELLO SCI.*







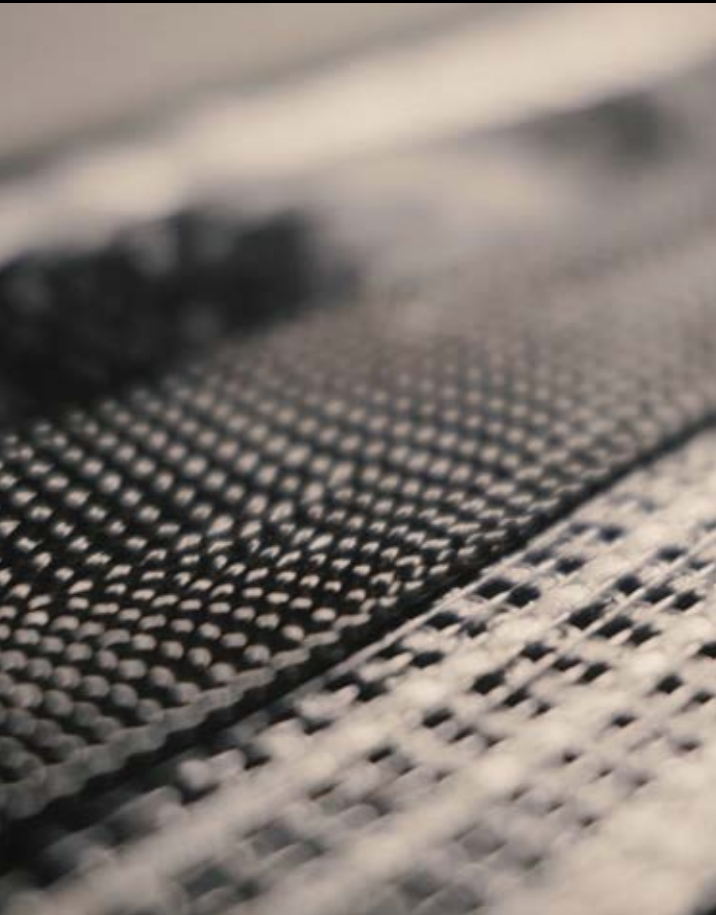

## **CRAFT FIRM** **CONSTANTLY LOOKING FOR NEW IDEAS AND INNOVATION**

### **WE MAKE INNOVATION DESIGN AND CONSTRUCTION**

WE HAVE INNOVATED, DESIGNED AND BUILT OUR PRODUCTS WITH PASSION FOR OVER 70 YEARS.

IN BORMIO, WHERE THEY ARE TESTED, REFINED AND WELL-LOVED.

WE DEVELOP NEW, CUTTING-EDGE PROJECTS, INTEGRATING TECHNOLOGICALLY ADVANCED METHODS, CRAFTSMANSHIP, DESIGN AND MAXIMUM ATTENTION TO DETAIL.

WE DO IT WITH THE SUPPORT OF THE BEST MOUNTAIN PROFESSIONALS.

WE HAVE THE EXPERIENCE AND FACILITIES TO BUILD COMPLEX CONSTRUCTIONS LIKE OUR EXCLUSIVE 14-LAYER LIGHTWEIGHT TECHNOLOGY. SKI TRAB, PASSION AND PERFORMANCE, DURABILITY AND RELIABILITY.

*IMMAGINIAMO, PROGETTIAMO E REALIZZIAMO CON PASSIONE I NOSTRI PRODOTTI DA OLTRE 70 ANNI.*

*A BORMIO, DOVE VENGONO TESTATI, CONSOLIDATI E DA SEMPRE APPREZZATI.*

*SVILUPPIAMO PROGETTI NUOVI ED EVOLUTI, INTEGRANDO LAVORAZIONI TECNOLOGICAMENTE AVANZATE, ARTIGIANALITÀ, DESIGN E MASSIMA CURA DEL DETTAGLIO.*

*LO FACCIAMO CON IL SUPPORTO DEI MIGLIORI PROFESSIONISTI DELLA MONTAGNA.*

*DISPONIAMO DI ESPERIENZA E STRUTTURE PER REALIZZARE COSTRUZIONE COMPLESSE COME L'ESCLUSIVA TECNOLOGIA DEL LEGGERO A 14 STRATI. SKI TRAB, PASSIONE E PERFORMANCE, DURABILITÀ ED AFFIDABILITÀ.*

## 2023/2024 ATHLETES

MAXIMILIEN DRION  
MATHÉO JACQUEMOUD  
ROBERT ANTONIOLI  
GIULIA COMPAGNONI  
NICOLÒ CANCLINI  
FEDERICO NICOLINI  
SAMANTHA BERTOLINA  
GIULIA MURADA  
ALESSANDRO ROSSI  
ILARIA VERONESE  
KATIA TOMATIS  
HANS INGE KLETTE  
ARNO LIETHA  
MARTIN ANTHAMATTEN  
VIKTORIA KREUZER  
GAY AURÉLIEN  
EKATERINA OSICHKINA  
MARTA GARCIA  
LÉO BESSON  
JUSTINE TONSO  
REMY GARCIN  
CORINNA GHIRARDI  
MATTEO SOSTIZZO  
ROCCO BALDINI  
LISA MORESCHINI  
LUCA TOMASONI  
SILVIA BERRA  
ROBIN BUSSARD  
THOMAS BUSSARD  
FLORIAN ULRICH  
RONYA LIETHA  
JOHANNA ÅSTRØM  
VEGARD ØIE  
FANNY BORGSTROM  
CAPUCINE BLANC  
NOÉ ROGIER

MARC RADUA IVERN  
TOMMASO COLOMBINI  
ERIKA SANELLI  
PIETRO FESTINI PURLAN  
GEORGE BECK  
TATJANA PALLER  
MANUELA PEDRANA  
MATTEO FAVRE  
IWONKA JANUSZYK  
JÉRÉMY ANSELMET  
MARA MARTINI  
GIOVANNI ROSSI  
EMELIE FORSBERG  
TOVE ALEXANDERSSON  
IDA WALDAL  
GABRIELE BARDEA  
SIMONE COMPAGNONI  
ANNA PEDRANZINI  
ALEX OBERBACHER  
ANSELME DAMEVIN  
BIEL PUJOL  
JULES RAYBAUD  
VANESSA MARCA  
MARCELA VASINOVA  
HENRIETTE ALBON  
ERIK KARVATN  
ORIOLOLM ROUPPERT  
NORICK POLCHI  
YANN LIVACHE  
ENRIC BAÑOS TOR  
LEONARDO TAUFER  
SILVIA BOSCACCI  
MARCELLO SCARINZI  
MARTINO UTZERI  
DAVIDE SAMBRIZZI





## 2023/2024 AMBASSADORS

---

WOLFGANG HELL  
GIULIANO BORDONI  
BRUNO MOTTINI  
FRANÇOIS CAZZANELLI  
LORENZO HOLZNECHT  
MARCO TREZZI  
LAETITIA ROUX  
GIORGIA FELICETTI  
BEN TIBBETS  
VALENTINE FABRE  
IVAN PEGORARI  
GIACOMO MENEGHELLO  
ADRIANO GRECO  
MANFRED REICHEGGER  
MATTEO CANOVA  
ENRICO MOSETTI  
CIPRIAN LOLU  
PHILIPP BRUGGER  
SIGNAR NILSEN  
BARD SMESTAD  
RAOUL CRETENAND  
FLORENT TROILLET  
STEFANO CONFORTOLA  
BUBU SALVADORI  
MAX CUSINI  
BENJAMIN VENDRINES  
PIETRO LANFRANCHI  
ALICE ARATA

### DISCOVER SKITRABBER STORIES



**2023/24**  
**SKIS COLLECTION**



**RACE TOURING SKIS**



**LIGHT PRO TOURING SKIS**

**PRO TOURING SKIS**

ORTLES 90 Liwood core



BERNINA 90 Liwood core



GAVIA 85 Liwood core



STELVIO 85 Liwood core



STELVIO FIT Liwood core



STELVIO KID Liwood core



STELVIO RENTAL Liwood core



NEVE Liwood core



TOURING SKIS

FREE TOURING SKIS

# CONSTRUCTION

## HIGH STRATIFICATION TECHNOLOGY TECNOLOGIA AD ALTA STRATIFICAZIONE

# 14 LAYER CONTROL

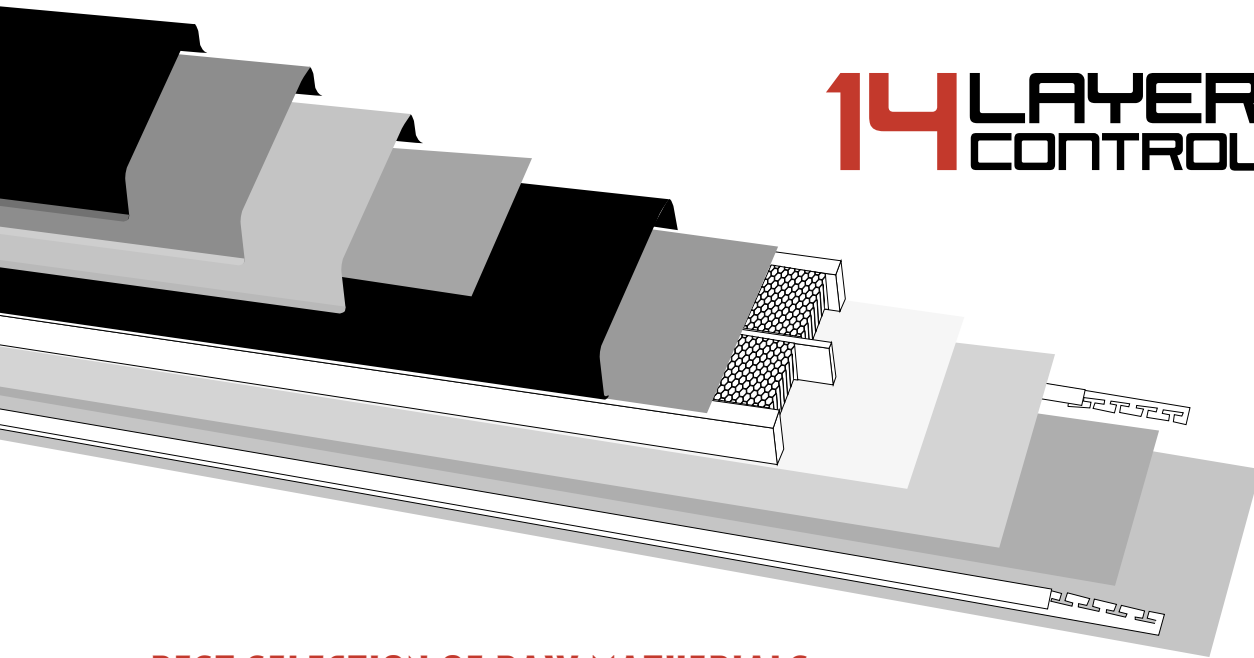

## BEST SELECTION OF RAW MATHERIALS SELEZIONE DELLE MIGLIORI MATERIE PRIME

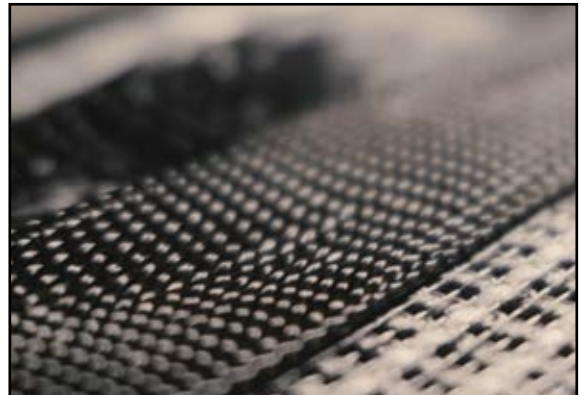
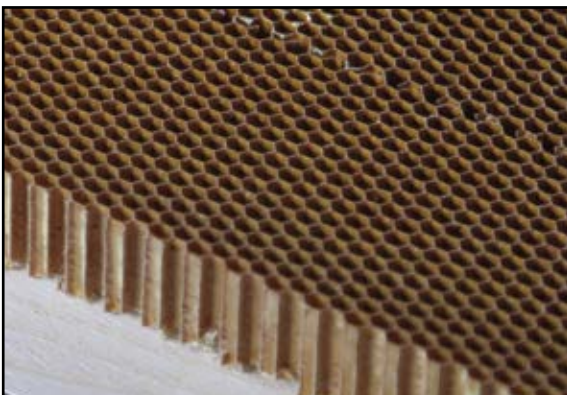

## AMIMA / CORE

### ARAMID CORE ANIMA IN ARAMIDE



ARAMID IS AMONG THE MOST IMPORTANT SYNTHETIC FIBRES. IT IS USED IN AEROSPACE AND MILITARY APPLICATIONS DUE TO ITS INCREDIBLE RESISTANCE FEATURES. THE ARAMID HONEYCOMB COMPOUND CORE REPRESENTS THE BEST STRENGTH/LIGHTWEIGHT RATIO AVAILABLE TODAY ON THE MARKET. SKI TRAB HAS CHOSEN THE BEST MATERIAL TO OBTAIN LONG-TERM HIGH STABILITY, PERFORMANCE AND DURABILITY OF THE SKIS.

*L'ARAMIDE È UNA TRA LE PIÙ IMPORTANTI FIBRE SINTETICHE. E' USATA NELLA TECNOLOGIA AEROSPAZIALE E MILITARE PER LE INCREDIBILI CARATTERISTICHE DI RESISTENZA. L'ANIMA ALVEOLARE IN ARAMIDE RAPPRESENTA IL MIGLIOR RAPPORTO FORZA/LEGGEREZZA OGGI SUL MERCATO, SKI TRAB HA SCELTO IL MIGLIOR MATERIALE PER MANTENERE ALTE NEL TEMPO LA STABILITÀ, LA PERFORMANCE E LA DURABILITÀ DELLO SCI.*

### LIWOOD AIR ANIMA IN LEGNO



THE SKI REMAINS LIGHT AND PERFORMS WELL, IMPROVING DURABILITY AND ENDURANCE. WOOD IS THE MOST USED RAW MATERIAL IN SKI PRODUCTION. FOR YEARS DESIGNERS HAVE SOUGHT AFTER A WOOD THAT IS LIGHTWEIGHT YET DURABLE AND STRONG, YET THIS GOES AGAINST NATURE. A LIGHTWEIGHT WOOD CORE NEEDS TO BE SUPPORTED BY PRODUCTION PROCESSES AND TO BE MIXED WITH OTHER TYPES OF WOOD TO IMPROVE ITS STRENGTH; ABOVE ALL IT MUST BE WRAPPED BY COMPOSITE MATERIALS WHICH GIVE IT TORSIONAL RIGIDITY AND DURABILITY. THE AIR DUCTS MAKE THE SKI LIGHTER WITHOUT COMPROMISING THE STRUCTURE.

LO SCI RIMANE LEGGERO E PERFORMANTE MIGLIORANDO DURATA E RESISTENZA. IL LEGNO È LA MATERIA PRIMA PIÙ USATA NEGLI SCI. DA ANNI SI È ALLA RICERCA DEL LEGNO LEGGERO MA ALLO STESSO TEMPO LO SI VORREBBE DURATURO E FORTE. SI VA CONTRO NATURA. L'ANIMA IN LEGNO LEGGERO DEVE ESSERE SUPPORTATA DA LAVORAZIONI E ACCOPPIAMENTI CON ALTRI LEGNI PER MIGLIORARE LA FORZA E SOPRATTUTTO AIUTATA DA MATERIALI IN COMPOSITO CHE AVVOLGENDOLA DANNO RIGIDITÀ TORSIONALE E DURABILITÀ. I CANALI D'ARIA APPPOSITAMENTE INSERITI RENDONO LO SCI PIÙ LEGGERO SENZA COMPROMETTERE LA STRUTTURA.

## TORSIONE / TORSION

### HIGH MODULE CARBON CAGE GABBIA IN CARBONIO AD ALTO MODULO



THIN MICRO-MESH CARBON CAGE (3K) WHICH WRAPS AROUND THE SKI PROVIDING A DEFINITELY HIGHER TORSIONAL STIFFNESS (UP TO 46%). THIS TYPE OF PROCESSING AIMS AT GIVING BENEFITS ONLY TO THE ANTITORSIONAL STRUCTURE WITHOUT COMPROMISING THE BENDING VALUES OF THE SKIS.

*GABBIA DI CARBONIO A TRAMA MOLTO SOTTILE (3K) CHE AVVOLGE INTERNAMENTE LO SCI, CONFERENDOGLI UNA RIGIDITÀ TORSIONALE DECISAMENTE SUPERIORE (FINO AL 46%). QUESTO TIPO DI LAVORAZIONE VA A BENEFICIO DELLA SOLA STRUTTURA ANTITORSIONE, SENZA PENALIZZARE I VALORI DI FLESSIONE DELLO SCI.*

### CARBON/GLASS CAGE GABBIA IN VETRO/CARBONIO



GGLASS/CARBON CAGE WHICH WRAPS AROUND THE SKI PROVIDING A HIGH TORSIONAL STIFFNESS. THIS TYPE OF PROCESSING AIMS AT GIVING BENEFITS ONLY TO THE ANTITORSIONAL STRUCTURE WITHOUT COMPROMISING THE BENDING VALUES OF THE SKIS.

*GABBIA DI CARBONIO/VETRO CHE AVVOLGE INTERNAMENTE LO SCI, CONFERENDOGLI RIGIDITÀ TORSIONALE. QUESTO TIPO DI LAVORAZIONE VA A BENEFICIO DELLA SOLA STRUTTURA ANTITORSIONE, SENZA PENALIZZARE I VALORI DI FLESSIONE DELLO SCI.*

# SIDECUT / SCIANCATURA

A LONGER TIP AND TAIL GUARANTEE BETTER FLOAT AND THEIR DIFFERENT SHAPE IMPROVES ENTRY INTO AND EXIT FROM TURNS. THE NEW RADIUSSES AND THE MOVEMENT OF THE BARYCENTRE FURTHER FORWARD, TOGETHER WITH A NEW TYPE OF FLEX GIVE THE SKI A DISTRIBUTION THAT FAVOURS CONTROL AND PERFORMANCE IN DESCENT.

FIND YOUR SKI AMONG 5 DIFFERENT SIDECUT WITH DIFFERENT FEATURES AND SIZES.

*PUNTA E CODA PIÙ LUNGHE GARANTISCONO UN MAGGIOR GALLEGGIAMENTO E LA LORO DIVERSA FORMA MIGLIORA INGRESSO ED USCITA DI CURVA. I NUOVI RAGGI ED IL BARICENTRO SPOSTATO IN AVANTI CON UN NUOVO TIPO DI FLEX DANNO ALLO SCI UN ASSETTO CHE FAVORISCE IL CONTROLLO E LA PERFORMANCE IN DISCESA.*

*TROVA IL TUO SCI TRA 5 SCIANCATURE CON CARATTERISTICHE E MISURE DIVERSE.*

	 <b>WIDTH 64</b>	 <p>TIP 92 mm CENTER 64 mm TAIL 79 mm</p>
---	--	--

**GARA WORLD CUP 60  
GARA WORLD CUP 60 WOMAN  
GARA WORLD CUP 70  
GARA**

	 <b>WIDTH 76</b>	 <p>TIP 108 mm CENTER 64 mm TAIL 94 mm</p>
---	--	---

**MAESTRO.2  
STELVIO FIT  
STELVIO KID**

	 <b>WIDTH 85</b>	 <p>TIP 92 mm CENTER 64 mm TAIL 79 mm</p>
--	---	---

**MAGICO.2  
ORTLES 85  
BERNINA 85  
STELVIO 85  
GAVIA 85  
STELVIO RT**

	 <b>WIDTH 90</b>	 <p>TIP 108 mm CENTER 64 mm TAIL 94 mm</p>
---	--	---

**MISTICO.2  
ORTLES 90  
BERNINA 90**

	 <b>WIDTH 93</b>	 <p>TIP 92 mm CENTER 64 mm TAIL 79 mm</p>
---	--	--

**NEVE**



# FLEX / FLESSIONE

THE FLEX OF A SKI IN RELATION TO THE RADIUS OF THE SIDECUT MAKES ALL THE DIFFERENCE. THE CONSTRUCTION AND THE MULTI-LAYER SKI TRAB TECHNOLOGY ALLOW FOR A VERY SOFT FLEX AT THE VERY ENDS OF THE SKI, MAKING IT EASY TO USE AND MANAGEABLE, ADAPTING EFFORTLESSLY TO ALL TYPES OF SNOW. AT ITS CENTRE THE SKI IS FIRMER, OFFERING GOOD TORSIONAL RIGIDITY AND EXCELLENT EDGE CONTROL, GUARANTEEING GOOD GRIP ON HARD, ICY SNOW. TOWARDS THE BACK OF THE SKI THE FLEX IS MORE ACCENTUATED, SO THAT DURING THE LOADING PHASE THE RADIUS OF THE SKI WORKS MORE TO IMPROVE STEERING AND CONTROL. THE MOUNTING HAS BEEN MOVED FORWARD IN ORDER TO IMPROVE THE TRIM OF THE SKI.

*IL FLEX DI UNO SCI ED IL RELATIVO ABBINAMENTO AI RAGGI DI SCIANCURATURA FANNO LA DIFFERENZA. LA COSTRUZIONE E LA TECNOLOGIA A MULTI STRATI SKI TRAB PERMETTONO DI OTTENERE UN FLEX MOLTO MORBIDO ALLE ESTREMITÀ DELLO SCI. LO SCI RISULTA FACILE E MANEGGEVOLE E SI ADATTA FACILMENTE ALLE NEVI CHE INCONTRA. IN ZONA CENTRALE LO SCI È PIÙ SOSTENUTO, OFFRE UN' IMPORTANTE RIGIDITÀ TORSIONALE ED UN OTTIMO CONTROLLO DEGLI SPIGOLI CON UNA GARANZIA DI OTTIMA PRESA SU NEVE DURA E GHIACCIATA. NELLA ZONA PIÙ ARRETRATA LO SCI HA UN FLEX PIÙ ACCENTUATO E PERMETTE IN FASE DI CARICO DI FAR LAVORARE MAGGIORMENTE IL RAGGIO DELLO SCI MIGLIORANDONE LA CONDUCIBILITÀ ED IL CONTROLLO. LA ZONA DI MONTAGGIO È STATA AVANZATA IN MODO DA MIGLIORARE L'ASSETTO SULLO SCI.*



**GARA WORLD CUP 60  
GARA WORLD CUP 60 WOMAN  
GARA WORLD CUP 70  
GARA**

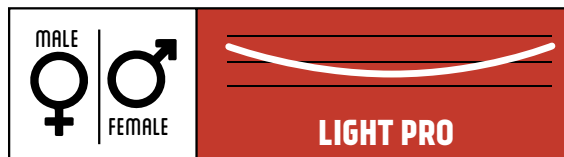

**MAESTRO.2  
MAGICO.2  
MISTICO.2**

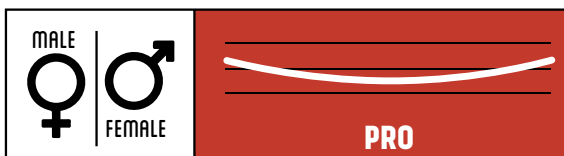

**ORTLES 85  
BERNINA 85**

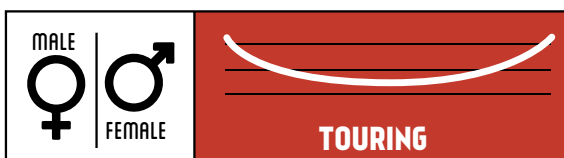

**STELVIO 85  
GAVIA 85  
STELVIO FIT  
STELVIO KID  
STELVIO RT**



**ORTLES 90  
BERNINA 90**



**NEVE**

# RACE TOURING SKIS



**HM CARBON AND ARAMID CORE**  
**THE MOST WINNING**  
**TOURING SKIS IN THE WORLD**  
**RELIABILITY & DURABILITY**





## TARGET USE

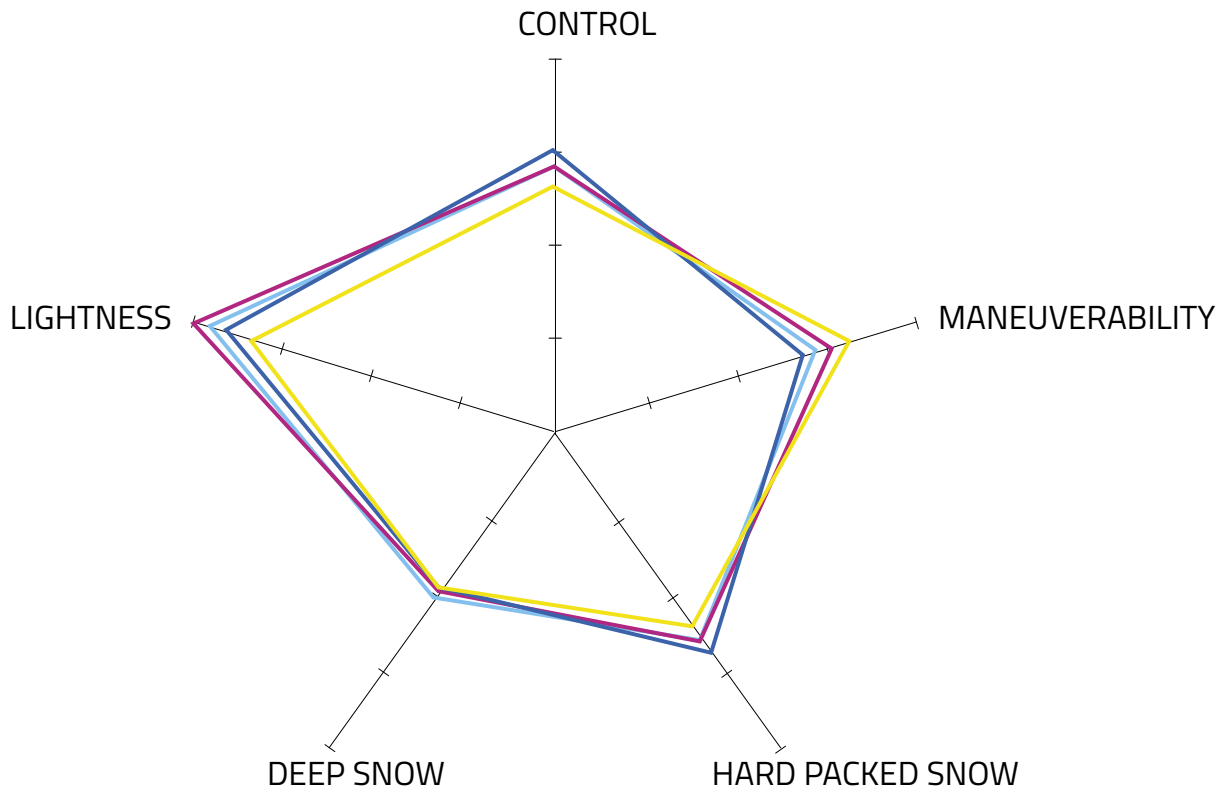

## **GARA WORLD CUP 60 WOMAN** **GARA WORLD CUP 60** **GARA WORLD CUP 70** **GARA**





RACE TOURING SKI - Cod. 13193

## GARA WORLD CUP 70

The most successful, reliable racing touring ski.  
Sustained flex for powerful skiers



### WHY CHOOSE IT

- THE MOST WINNING SKI IN COMPETITIONS
- FLEX 70, FOR HEAVY ATHLETES OR STRONG SKIER
- RELIABILITY, GUARANTEED BY THE 14-LAYER GARA CONTROL
- SUPERLIGHTWEIGHT HONEYCOMB CORE IN ARAMID AND WOOD **1**
- THE BRIDGE BETWEEN THE EDGES TO BETTER WITHSTAND IMPACTS **2**
- BETTER FLOATATION AND CONTROL
- NEW GEOMETRY FOR A DYNAMIC STRIDE
- HIGH MODULE CARBON TORSION BOX **3**



### CONSTRUCTION

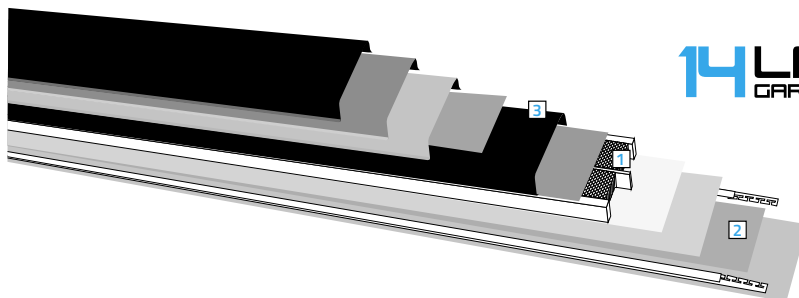

**14 LAYER**  
GARA CONTROL



### GEOMETRY



SIZE (CM)	162	169
WEIGHT (GR)	710	745
RADIUS (MT)	23.6	24.8
SURFACE (CM <sup>2</sup> )	1164	1206
SIDECUT (MM)	92/64/79	92/63/79

### FLEX

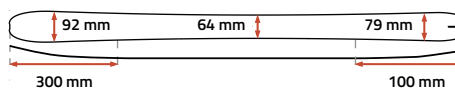



RACE TOURING SKI - Cod. 13192

## GARA WORLD CUP 60

The most successful, reliable race touring ski. Soft flex for ease of use



### WHY CHOOSE IT

- THE MOST WINNING SKI IN COMPETITIONS
- FLEX 60, FOR LIGHT ATHLETES
- RELIABILITY, GUARANTEED BY THE 14-LAYER GARA CONTROL
- SUPERLIGHTWEIGHT HONEYCOMB CORE IN ARAMID AND WOOD **1**
- THE BRIDGE BETWEEN THE EDGES TO BETTER WITHSTAND IMPACTS **2**
- BETTER FLOATATION AND CONTROL
- NEW GEOMETRY FOR A DYNAMIC STRIDE
- HIGH MODULE CARBON TORSION BOX **3**



### CONSTRUCTION

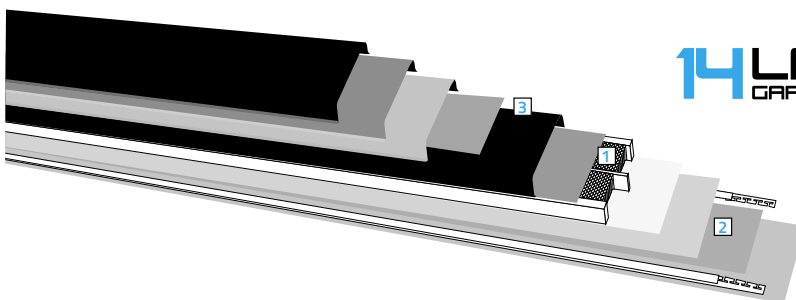

**14 LAYER**  
GARA CONTROL



### GEOMETRY



SIZE (CM)	162
WEIGHT (GR)	700
RADIUS (MT)	23.6
SURFACE (CM <sup>2</sup> )	1164
SIDECUT (MM)	92/64/79

### FLEX

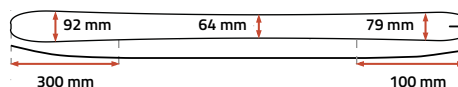



RACE TOURING SKI - Cod. 13192W

# GARA WORLD CUP 60

The most successful, reliable racing touring ski. Soft flex for woman.



## WHY CHOOSE IT

- THE MOST WINNING SKI IN COMPETITIONS
- FLEX 60, FOR WOMAN
- RELIABILITY, GUARANTEED BY THE 14-LAYER GARA CONTROL
- SUPERLIGHTWEIGHT HONEYCOMB CORE IN ARAMID AND WOOD **1**
- THE BRIDGE BETWEEN THE EDGES TO BETTER WITHSTAND IMPACTS **2**
- BETTER FLOATATION AND CONTROL
- NEW GEOMETRY FOR A DYNAMIC STRIDE
- HIGH MODULE CARBON TORSION BOX **3**



## CONSTRUCTION

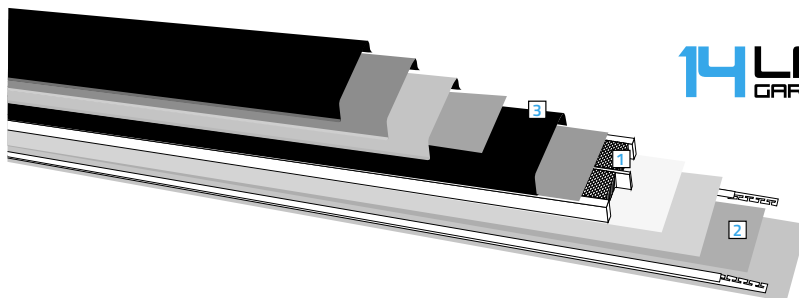

**14 LAYER**  
GARA CONTROL



**ARAMID**  
HONEYCOMB AERO CORE



**CARBON HM**  
HIGH MODULE CARBON CAGE

## GEOMETRY



SIZE (CM)	155
WEIGHT (GR)	685
RADIUS (MT)	21,3
SURFACE (CM2)	1113
SIDECUT (MM)	92/64/79

## FLEX



MALE  
FEMALE

RACE FLEX

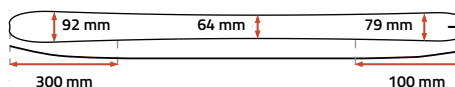



**RACE TOURING SKI - Cod. 13194**

# GARA

Lightweight in training, reliable when racing.  
Excellent durability.



## WHY CHOOSE IT

- RELIABILITY, GUARANTEED BY THE 14-LAYER GARA CONTROL
- THE BRIDGE BETWEEN THE EDGES TO BETTER WITHSTAND IMPACTS <sup>1</sup>
- BETTER FLOATATION AND CONTROL
- NEW GEOMETRY FOR A DYNAMIC STRIDE
- IMPROVED DURABILITY
- BEST PRICE PERFORMANCE RATIO
- EASE OF USE
- HIGH MODULE CARBON TORSION BOX <sup>2</sup>



## CONSTRUCTION

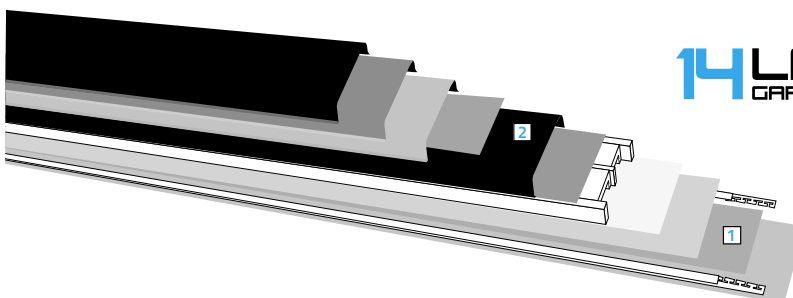

**14 LAYER**  
GARA CONTROL

**LIWOOD AIR**  
DIFFERENTIATED AERO  
WOOD CORE

**CARBON HM**  
HIGH MODULE CARBON CAGE

## GEOMETRY

**WIDTH 64**

SIZE (CM)	155	162	169
WEIGHT (GR)	730	760	795
RADIUS (MT)	21,3	23,6	24,8
SURFACE (CM <sup>2</sup> )	1113	1164	12 06
SIDECUT (MM)	92/64/79	92/64/79	92/63/79

## FLEX

**RACE FLEX**

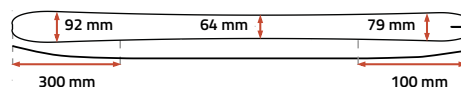

# LIGHT PRO TOURING SKIS

---



**HM CARBON WITH ARAMID CORE  
AND MIXED WOOD**

**TOP PERFORMANCE**

**RELIABILITY & DURABILITY**

**LIGHTNESS**

**HIGH TORSIONAL RIGIDITY**





## TARGET USE

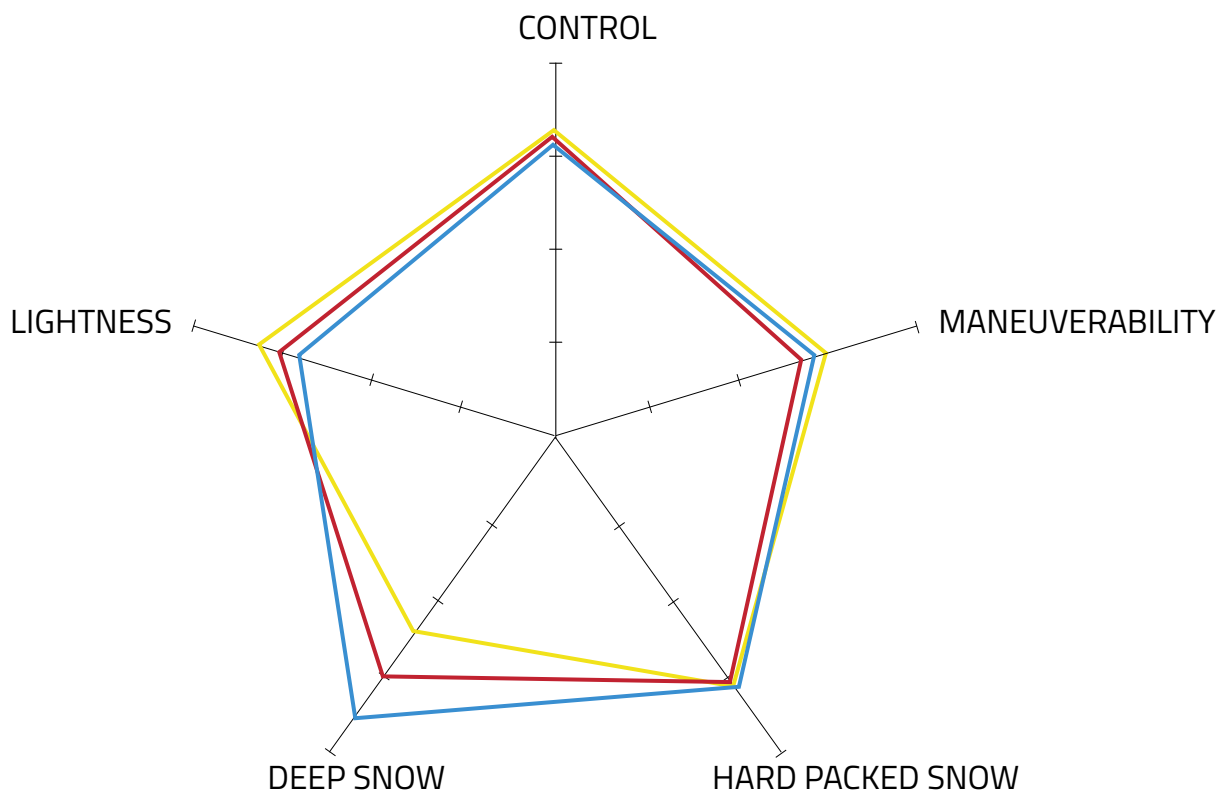

**MAESTRO.2**  
**MAGICO.2**  
**MISTICO.2**





**LIGHT PRO TOURING SKI - Cod. 13195**

# MAESTRO.2

HM Carbon with Aramid core and mixed wood.  
Extremely lightweight and reliable for the biggest adventures.



## WHY CHOOSE IT

- THE MOST TECHNICAL MODEL, LIGHTWEIGHT AND POWERFUL.
- THE LIGHTEST SKI IN TOURING COLLECTION
- RELIABILITY, GUARANTEED BY THE 14-LAYER CONTROL
- SUPERLIGHTWEIGHT HONEYCOMB CORE IN ARAMID AND WOOD **1**
- THE BRIDGE BETWEEN THE EDGES TO BETTER WITHSTAND IMPACTS **2**
- HIGH MODULE CARBON CAGE **3**
- NEW GEOMETRY FOR BETTER CONTROL, BETTER FLOATATION AND EASY TURNING



## CONSTRUCTION

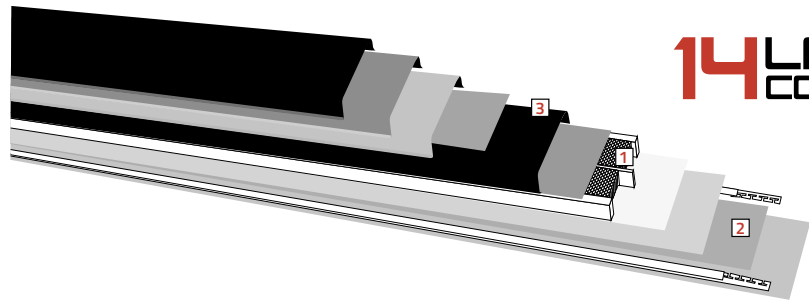

**14 LAYER CONTROL**



**ARAMID**  
HONEYCOMB AERO CORE



**CARBON HM**  
HIGH MODULE CARBON CAGE

## GEOMETRY



<b>SIZE (CM)</b>	157	164	171	178
<b>WEIGHT (GR)</b>	890	925	953	1000
<b>RADIUS (MT)</b>	20,50	21,70	22	24,10
<b>SURFACE (CM2)</b>	1369	1420	1461	1519
<b>SIDECUT (MM)</b>	108/79/94	108/78/94	108/76/94	108/76/94

## FLEX

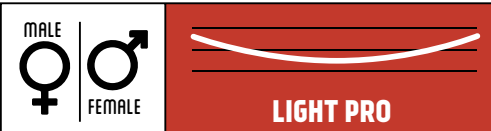

**LIGHT PRO**

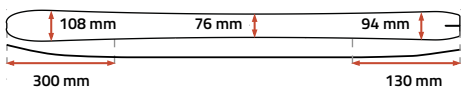



**LIGHT PRO TOURING SKI - Cod. 13196**

# MAGICO.2

HM Carbon with Aramid core and mixed wood.

The ultimate combination of ascent and descent in one ski



## WHY CHOOSE IT

- POWERFUL, TECHNICAL AND LIGHTWEIGHT
- THE BEST COMBINATION OF ASCENT AND DESCENT
- RELIABILITY, GUARANTEED BY THE 14-LAYER CONTROL
- SUPERLIGHTWEIGHT HONEYCOMB CORE IN ARAMID AND WOOD <sup>1</sup>
- THE BRIDGE BETWEEN THE EDGES TO BETTER WITHSTAND IMPACTS <sup>2</sup>
- HIGH MODULE CARBON CAGE <sup>3</sup>
- NEW GEOMETRY FOR BETTER CONTROL, BETTER FLOATATION AND EASY TURNING



## CONSTRUCTION

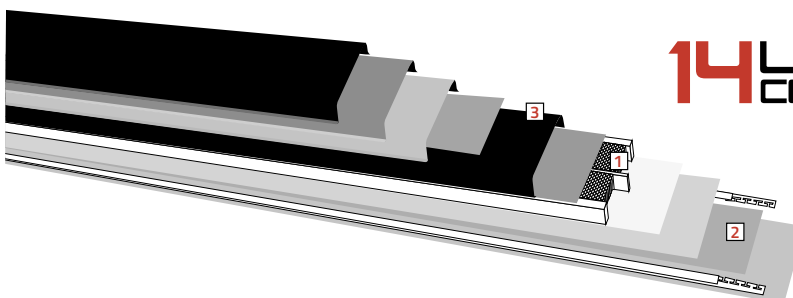

**14 LAYER CONTROL**



## GEOMETRY



SIZE (CM)	157	164	171	178
WEIGHT (GR)	990	1020	1050	1100
RADIUS (MT)	19,50	20,08	21,10	23,10
SURFACE (CM <sup>2</sup> )	1511	1569	1616	1682
SIDECUT (MM)	118/88/104	118/87/104	118/85/104	118/85/104

## FLEX

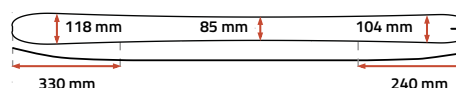



**LIGHT PRO TOURING SKI - Cod. 13197**

## MISTICO.2

HM Carbon with Aramid core and mixed wood.

Maximum control, steering and floatation in a Lightweight ski.

### WHY CHOOSE IT

- LIGHTWEIGHT WITH BEST DOWNHILL PERFORMANCE OF THE LINE
- THE BEST COMBINATION OF ASCENT AND DESCENT
- RELIABILITY, GUARANTEED BY THE 14-LAYER CONTROL
- SUPERLIGHTWEIGHT HONEYCOMB CORE IN ARAMID AND WOOD **1**
- THE BRIDGE BETWEEN THE EDGES TO BETTER WITHSTAND IMPACTS **2**
- HIGH MODULE CARBON CAGE **3**
- NEW GEOMETRY FOR BETTER CONTROL, BETTER FLOATATION AND EASY TURNING



### CONSTRUCTION

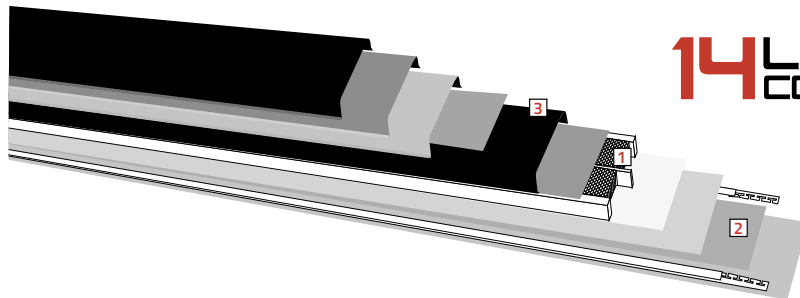

**14 LAYER CONTROL**



### GEOMETRY



SIZE (CM)	157	164	171	178
WEIGHT (GR)	1020	1060	1100	1150
RADIUS (MT)	19,1	21,2	21,5	23,6
SURFACE (CM <sup>2</sup> )	1575	1644	1695	1764
SIDECUT (MM)	122/92/109	122/92/109	122/90/109	122/90/109

### FLEX

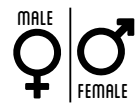
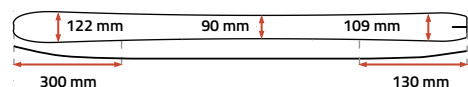



# PRO TOURING SKIS



**HM CARBON AND LIWOOD CORE**  
**MAXIMUM CONTROL,**  
**STEERING AND FLOATATION**  
**RELIABILITY & DURABILITY**  
**HIGH TORSIONAL RIGIDITY**



## TARGET USE

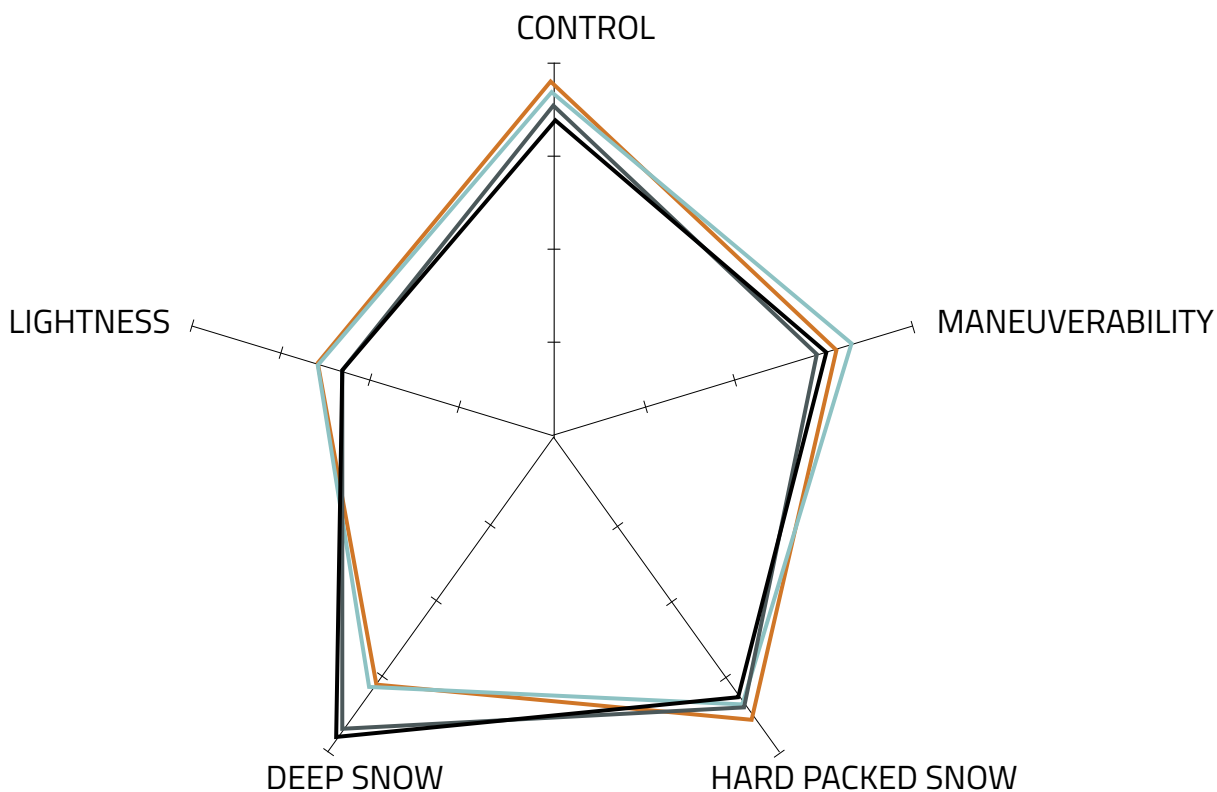

**ORTLES 85**  
**BERNINA 85**  
**ORTLES 90**  
**BERNINA 90**



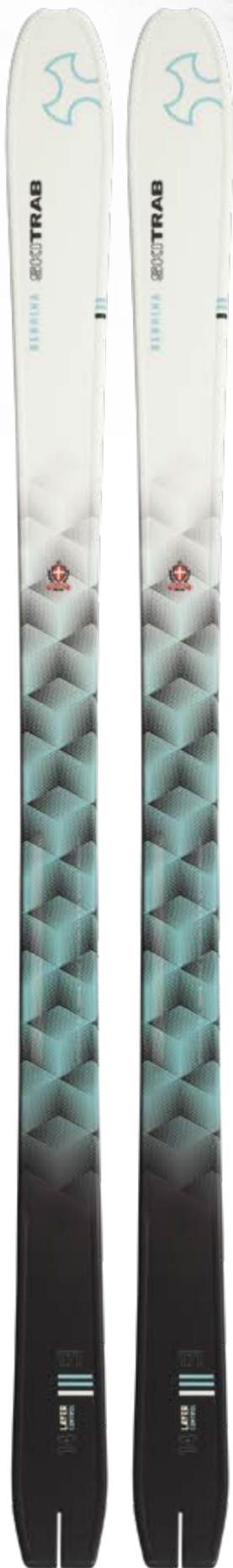

**PRO TOURING SKI - Cod. 13188**

# BERNINA 85

HM Carbon and LIWOOD core with soft flex.

Maximum control, steering and reliability.



## WHY CHOOSE IT

BEST DOWNHILL PERFORMANCE OF WOMEN LINE  
 FOR DEMANDING SKIERS WITH A GOOD LEVEL OF TECHNICAL SKILL  
 FOR WOMAN OR FOR LIGHTER SKIERS  
 RELIABILITY, GUARANTEED BY THE 14-LAYER CONTROL  
 THE BRIDGE BETWEEN THE EDGES TO BETTER WITHSTAND IMPACTS <sup>1</sup>  
 HIGH MODULE CARBON CAGE <sup>2</sup>  
 NEW GEOMETRY FOR BETTER CONTROL, BETTER FLOATATION AND EASY TURNING



## CONSTRUCTION

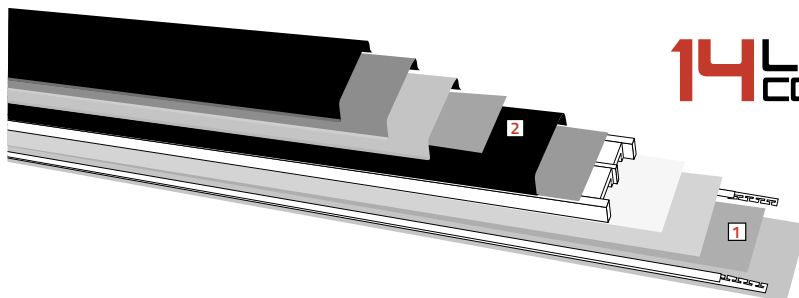

**14 LAYER CONTROL**



## GEOMETRY



<b>SIZE (CM)</b>	157	164	171	178
<b>WEIGHT (GR)</b>	990	1030	1080	1120
<b>RADIUS (MT)</b>	19,5	20,8	21,1	23,1
<b>SURFACE (CM<sup>2</sup>)</b>	1511	1569	1616	1682
<b>SIDECUT (MM)</b>	118/88/104	118/88/104	118/87/104	118/85/104

## FLEX

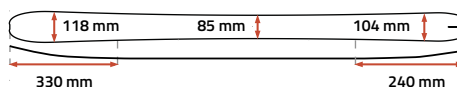
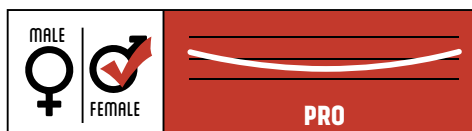





PRO TOURING SKI - Cod. 13184

## ORTLES 85

HM Carbon and LIWOOD AIR core.

Maximum control, steering and precision.



### WHY CHOOSE IT

BEST DOWNHILL PERFORMANCE OF WOMEN LINE  
 FOR DEMANDING SKIERS WITH A GOOD LEVEL OF TECHNICAL SKILL  
 RELIABILITY, GUARANTEED BY THE 14-LAYER CONTROL  
 THE BRIDGE BETWEEN THE EDGES TO BETTER WITHSTAND IMPACTS **1**  
 HIGH MODULE CARBON CAGE **2**  
 NEW GEOMETRY FOR BETTER CONTROL, BETTER FLOATATION AND EASY TURNING



### CONSTRUCTION

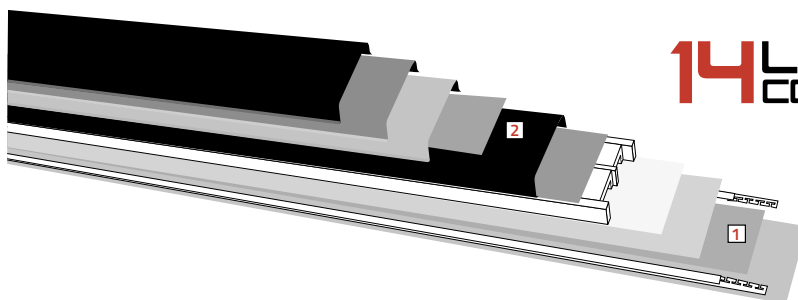

### GEOMETRY



SIZE (CM)	157	164	171	178
WEIGHT (GR)	1030	1080	1120	1150
RADIUS (MT)	19,5	21,8	21,1	23,1
SURFACE (CM <sup>2</sup> )	1511	1569	1616	1682
SIDECUT (MM)	118/88/104	118/88/104	118/87/104	118/85/104

### FLEX

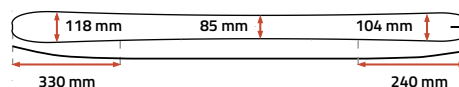



PRO TOURING SKI - Cod. 13198

## BERNINA 90

HM Carbon and LIWOOD core with soft flex.  
Maximum control, steering and floatation.



### WHY CHOOSE IT

ORTLES WIDER VERSION  
BEST DOWNHILL PERFORMANCE OF THE LINE  
FOR DEMANDING SKIERS WITH A GOOD LEVEL OF TECHNICAL SKILL  
FOR WOMAN OR FOR LIGHTER SKIERS  
RELIABILITY, GUARANTEED BY THE 14-LAYER CONTROL  
THE BRIDGE BETWEEN THE EDGES TO BETTER WITHSTAND IMPACTS **1**  
HIGH MODULE CARBON CAGE **2**  
NEW GEOMETRY FOR BETTER CONTROL, BETTER FLOATATION AND EASY TURNING



### CONSTRUCTION

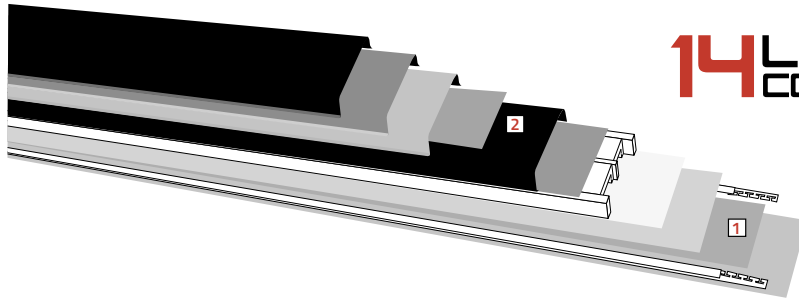

**14** LAYER CONTROL

**LIWOOD AIR**  
DIFFERENTIATED AERO  
WOOD CORE



**CARBON HM**  
HIGH MODULE CARBON CAGE

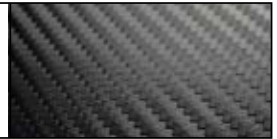

### GEOMETRY

**WIDTH 90**

SIZE (CM)	157	164	171
WEIGHT (GR)	1060	1120	1170
RADIUS (MT)	19,1	21,2	21,5
SURFACE (CM <sup>2</sup> )	1557	1644	1695
SIDECUT (MM)	122/92/109	122/92/109	122/90/109

### FLEX

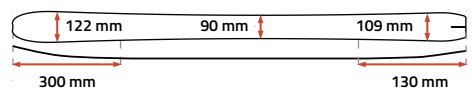



PRO TOURING SKI - Cod. 13189

# ORTLES 90

HM Carbon and LIWOOD AIR core.  
Maximum control, steering and floatation.



## WHY CHOOSE IT

- ORTLES WIDER VERSION
- BEST DOWNHILL PERFORMANCE OF THE LINE
- FOR DEMANDING SKIERS WITH A GOOD LEVEL OF TECHNICAL SKILL
- RELIABILITY, GUARANTEED BY THE 14-LAYER CONTROL
- THE BRIDGE BETWEEN THE EDGES TO BETTER WITHSTAND IMPACTS <sup>1</sup>
- HIGH MODULE CARBON CAGE <sup>2</sup>
- NEW GEOMETRY FOR BETTER CONTROL, BETTER FLOATATION AND EASY TURNING



## CONSTRUCTION

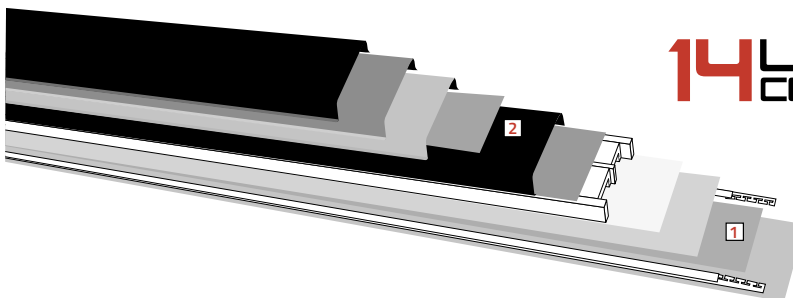

**14 LAYER CONTROL**



**LIWOOD AIR**  
DIFFERENTIATED AERO  
WOOD CORE



**CARBON HM**  
HIGH MODULE CARBON CAGE

## GEOMETRY



**WIDTH 90**

SIZE (CM)	157	164	171	178
WEIGHT(GR)	1060	1120	1170	1230
RADIUS(MT)	19,1	21,2	21,5	23,6
SURFACE(CM2)	1575	1644	1695	1754
SIDECUT(MM)	122/92/109	122/92/109	122/90/109	122/90/109

## FLEX



**FREE & TOUR**

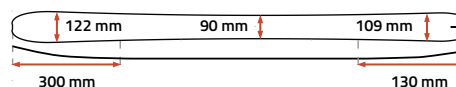

# TOURING SKIS

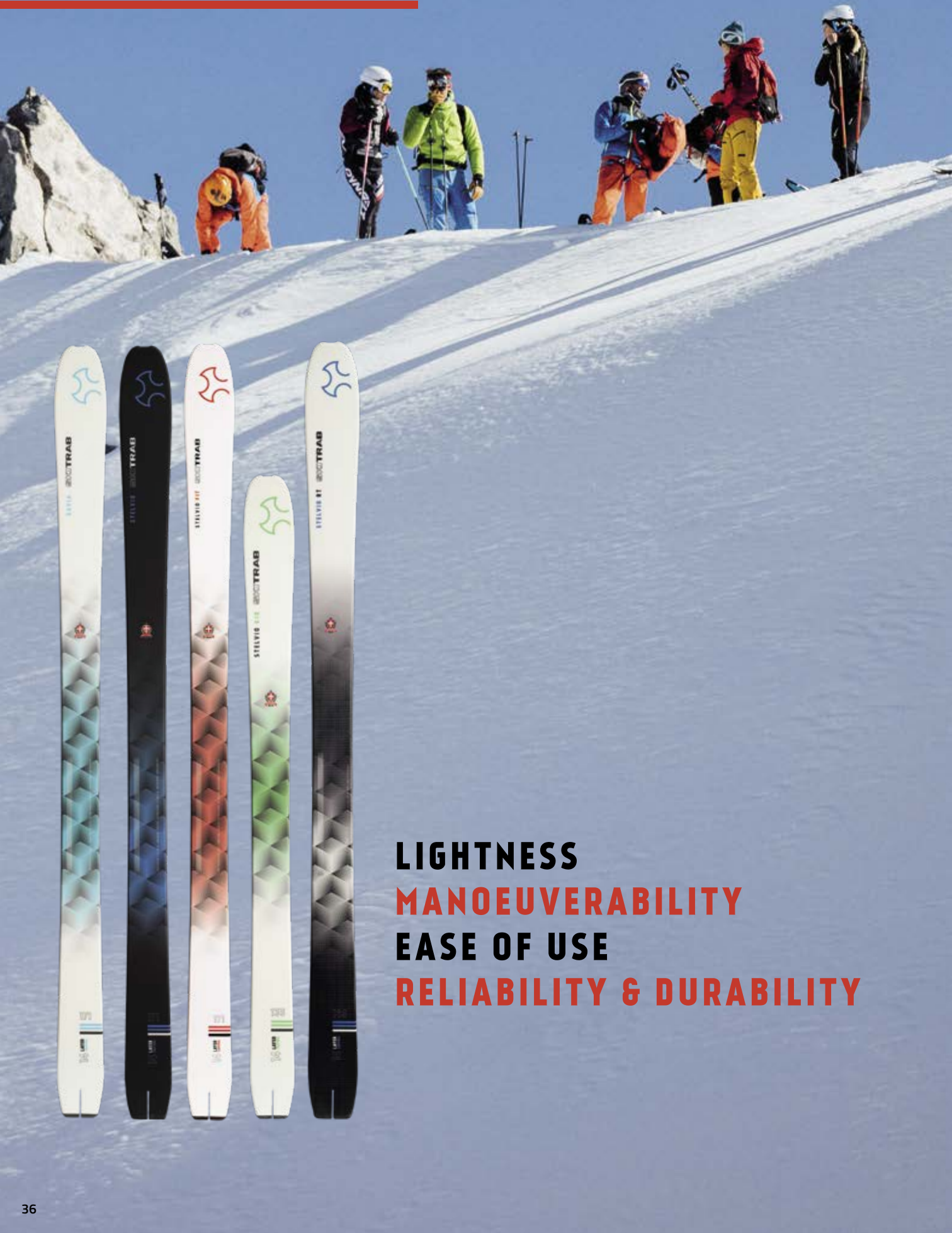

**LIGHTNESS**  
**MANOEUVERABILITY**  
**EASE OF USE**  
**RELIABILITY & DURABILITY**



## TARGET USE

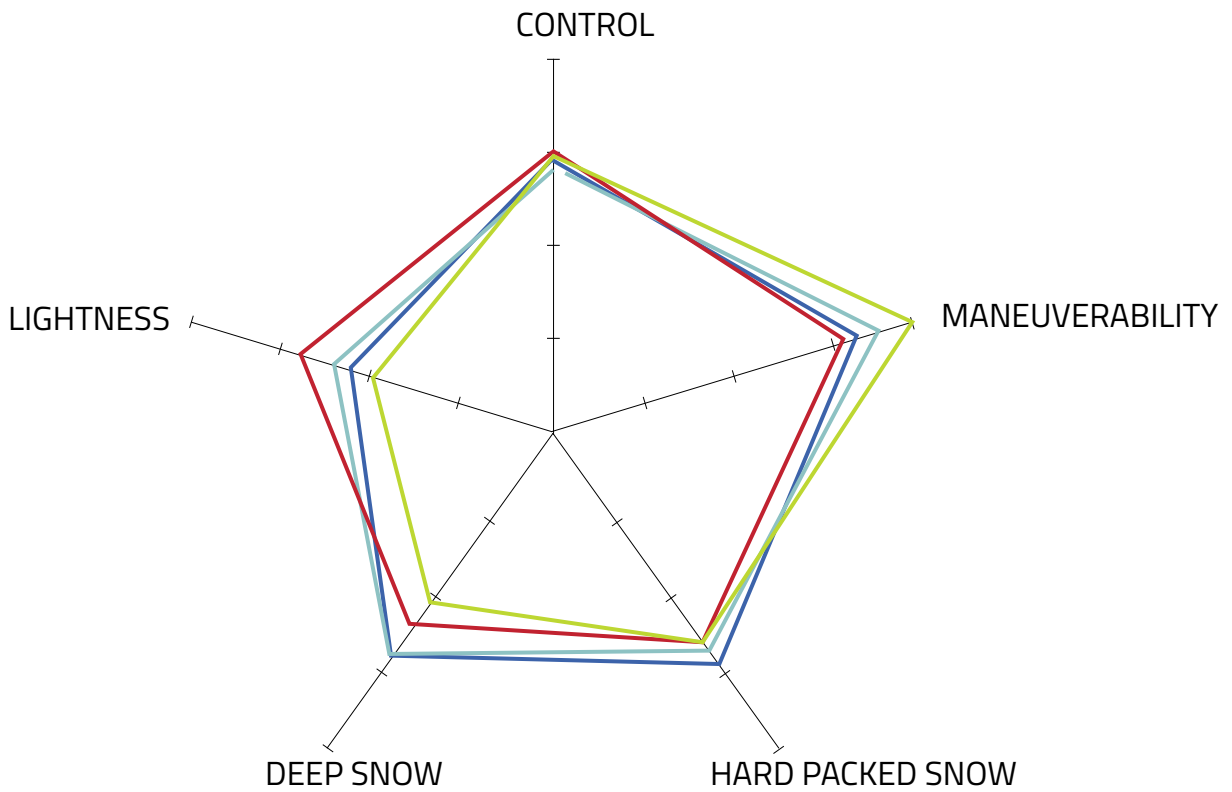

### GAVIA STELVIO STELVIO FIT STELVIO KID



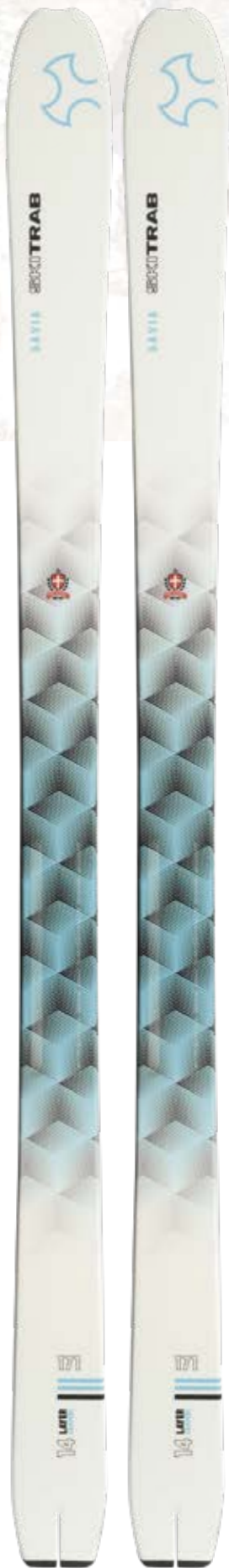

**TOURING SKI - Cod. 13186**

# GAVIA 85

Fun, agile and excellent ski on all types of snow  
Soft flex for improved ease of use



## WHY CHOOSE IT

EASILY MANOEUVRABLE SKI TO USE IN ALL TYPES OF SNOW  
FOR WOMEN OR FOR LIGHTER SKIERS  
RELIABILITY, GUARANTEED BY THE 14-LAYER CONTROL  
THE BRIDGE BETWEEN THE EDGES TO BETTER WITHSTAND IMPACTS **1**  
NEW GEOMETRY FOR BETTER CONTROL,  
BETTER FLOATATION AND EASY TURNING



## CONSTRUCTION

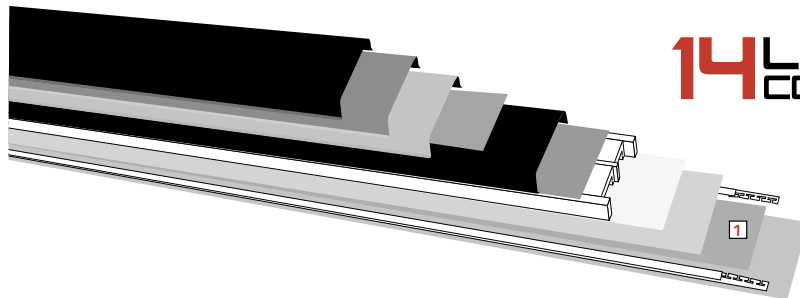

## GEOMETRY



SIZE (CM)	150	157	164	171	178
WEIGHT(GR)	1015	1065	1109	1160	1200
RADIUS(MT)	17,50	19,50	20,08	21,10	23,10
SURFACE(CM2)	1444	1511	1569	1616	1682
SIDECUT(MM)	118/88/104	118/88/104	118/87/104	118/85/104	118/85/104

## FLEX

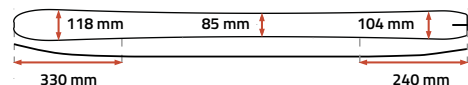



TOURING SKI - Cod. 13185

## STELVIO 85

Fun, agile and excellent on all types of snow.  
Sustained flex for better stability



### WHY CHOOSE IT

EASILY MANOEUVRABLE SKI TO USE IN ALL TYPES OF SNOW FOR THOSE LOOKING FOR GREATER SUPPORT BETWEEN THE CENTRE AND THE TAIL  
RELIABILITY, GUARANTEED BY THE 14-LAYER CONTROL  
THE BRIDGE BETWEEN THE EDGES TO BETTER WITHSTAND IMPACTS **1**  
NEW GEOMETRY FOR BETTER CONTROL,  
BETTER FLOATATION AND EASY TURNING



### CONSTRUCTION

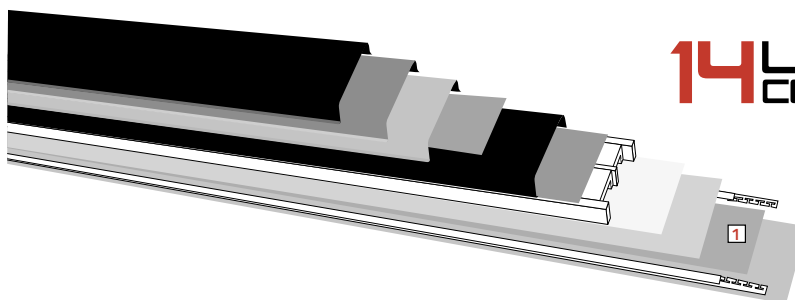

**14** LAYER CONTROL



### GEOMETRY



SIZE (CM)	150	157	164	171	178
WEIGHT (GR)	1050	1100	1150	1200	1270
RADIUS (MT)	17,50	19,50	20,08	21,10	23,10
SURFACE (CM <sup>2</sup> )	1444	1511	1569	1616	1682
SIDECUT (MM)	118/88/104	118/88/104	118/87/104	118/85/104	118/85/104

### FLEX

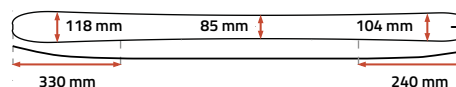



**TOURING SKI - Cod. 13190**

# STELVIO FIT

The joy of hiking with touring skis  
Lightweight, easy to use and reliable for a workout on skise



## WHY CHOOSE IT

EASILY MANOEUVRABLE SKI  
FOR THOSE LOOKING FOR A SKI SUITABLE FOR EASY TERRAIN (SLOPE OR ROAD)  
RELIABILITY, GUARANTEED BY THE 14-LAYER CONTROL  
THE BRIDGE BETWEEN THE EDGES TO BETTER WITHSTAND IMPACTS **1**  
NEW GEOMETRY FOR BETTER CONTROL AND EASY TURNING



## CONSTRUCTION

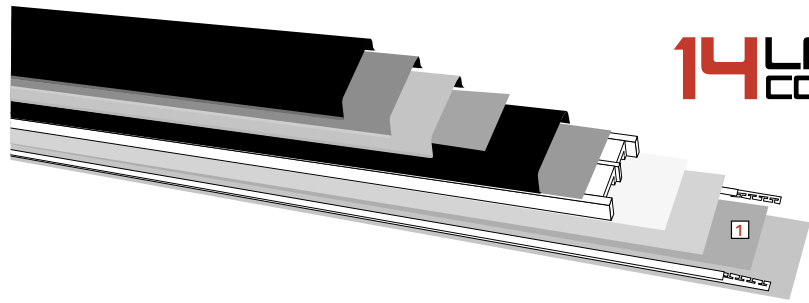

# 14 LAYER CONTROL



**LIWOOD AIR**  
DIFFERENTIATED AERO  
WOOD CORE





**CARBON GLASS**  
CARBON/GLASS TORSION CAGE



## GEOMETRY



**WIDTH 76**

SIZE (CM)	150	157	164	171	178
WEIGHT(GR)	955	1000	1045	1090	1130
RADIUS(MT)	18,40	20,50	21,70	22	24,10
SURFACE(CM2)	1308	1369	1420	1461	1519
SIDECUT(MM)	108/79/94	108/79/94	108/78/94	108/76/94	108/76/94

## FLEX

MALE



FEMALE



**TOURING**

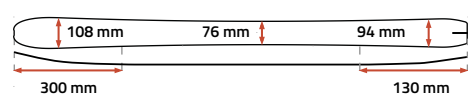





**TOURING SKI - Cod. 13191**  
**STELVIO KID**

Ski touring for kids.  
 Lightweight, responsive, ease of use



**WHY CHOOSE IT**

EASILY MANOEUVRABLE SKI FOR YOUNGER SKITOURERS  
 RELIABILITY, GUARANTEED BY THE 14-LAYER CONTROL  
 THE BRIDGE BETWEEN THE EDGES TO BETTER WITHSTAND IMPACTS **1**  
 NEW GEOMETRY FOR BETTER CONTROL AND EASY TURNING



**CONSTRUCTION**

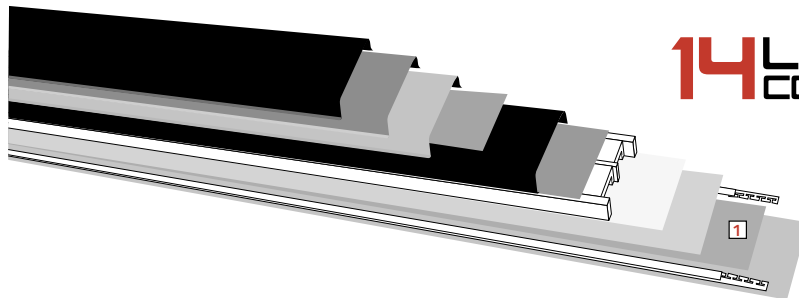

**14 LAYER CONTROL**



**GEOMETRY**



SIZE (CM)	135
WEIGHT (GR)	830
RADIUS (MT)	15
SURFACE (CM2)	1188
SIDECUT (MM)	108/80/94

**FLEX**

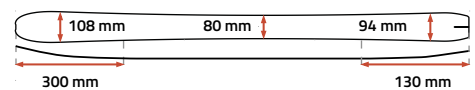



TOURING SKI - Cod. 13187

# STELVIO RENTAL

Fun, agile and excellent ski on all types of snow.  
Maximum durability for rental.



## WHY CHOOSE IT

- EASILY MANOEUVRABLE SKI
- MAXIMUM DURABILITY
- RELIABILITY, GUARANTEED BY THE 14-LAYER CONTROL
- THE BRIDGE BETWEEN THE EDGES TO BETTER WITHSTAND IMPACTS **1**
- NEW GEOMETRY FOR BETTER CONTROL AND EASY TURNING



## CONSTRUCTION

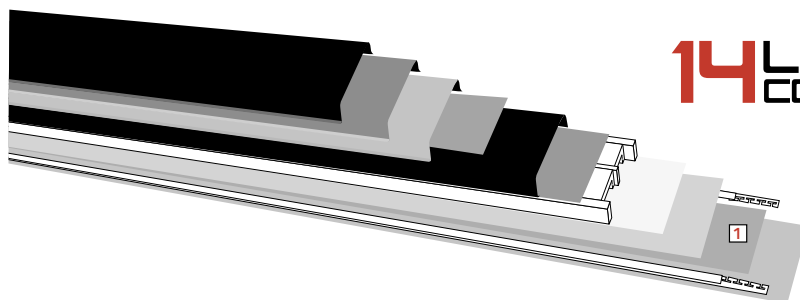

**14 LAYER CONTROL**

**LIWOOD AIR**  
DIFFERENTIATED AERO WOOD CORE

**CARBON GLASS**  
CARBON/GLASS TORSION CAGE

## GEOMETRY

**WIDTH 85**

SIZE (CM)	150	157	164	171	178
WEIGHT(GR)	1090	1150	1200	1240	1290
RADIUS(MT)	17,50	19,50	20,08	21,10	23,10
SURFACE(CM2)	1444	1511	1569	1616	1682
SIDECUT(MM)	118/88/104	118/88/104	118/87/104	118/85/104	118/85/104

## FLEX

MALE FEMALE

**TOURING**

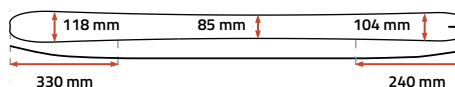



# FREETOURING SKIS

---



**FLOATATION**  
**CONTROL**  
**DETAILS**  
**RELIABILITY & DURABILITY**



## TARGET USE

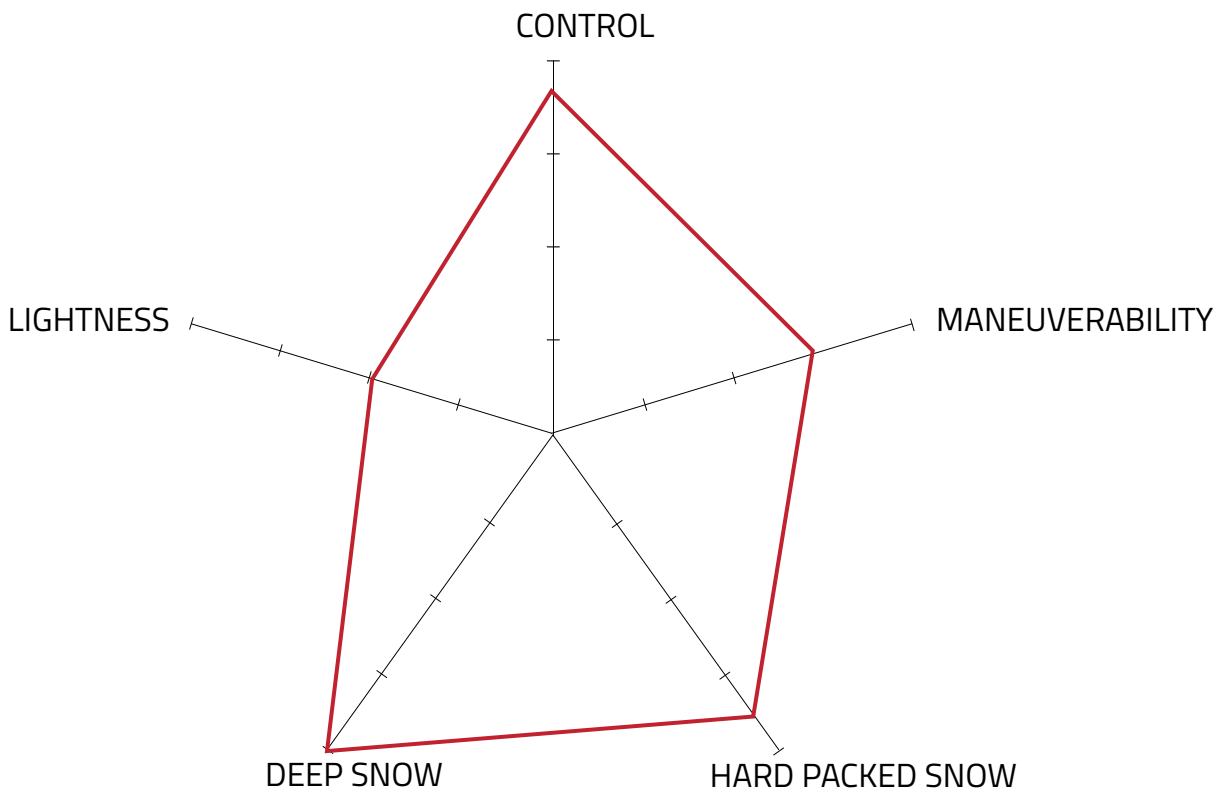

## NEVE





**TOURING SKI - Cod. 13182**

# NEVE SPECIAL EDITION

The touring ski especially created for those who go hard in descent



## WHY CHOOSE IT

- THE BEST DOWNHILL PERFORMANCE OF THE SKI TRAB SKIS FOR DEMANDING SKIERS WITH A GOOD LEVEL OF TECHNICAL SKILL
- RELIABILITY, GUARANTEED BY THE 14-LAYER CONTROL
- THE SUPPORTIVE FLEX
- THE EDGE BOOST
- NEW GEOMETRY FOR BETTER CONTROL AND BETTER FLOATATION
- EXTRA LONG TIP AND TAIL



## CONSTRUCTION

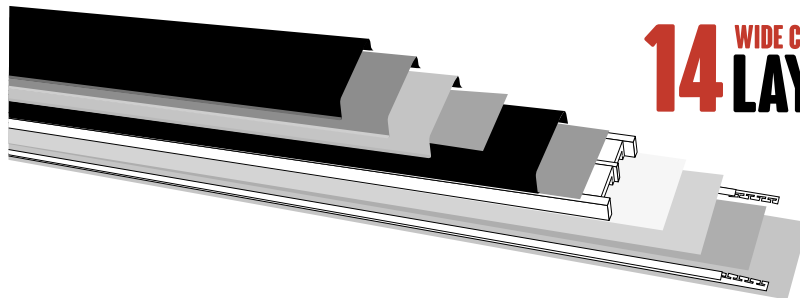



**LIWOOD AIR**  
DIFFERENTIATED AERO  
WOOD CORE





**CARBON GLASS**  
CARBON/GLASS TORSION CAGE



## GEOMETRY



**WIDTH 93**

SIZE (CM)	174	181	188
WEIGHT(GR)	1380	1450	1520
RADIUS(MT)	23.7	24.5	27.2
SURFACE(CM2)	1783	1844	1914
SIDECUT(MM)	123/93/113	123/93/113	123/93/113

## FLEX

MALE



FEMALE



**FREETOUR**

# GEOMETRY

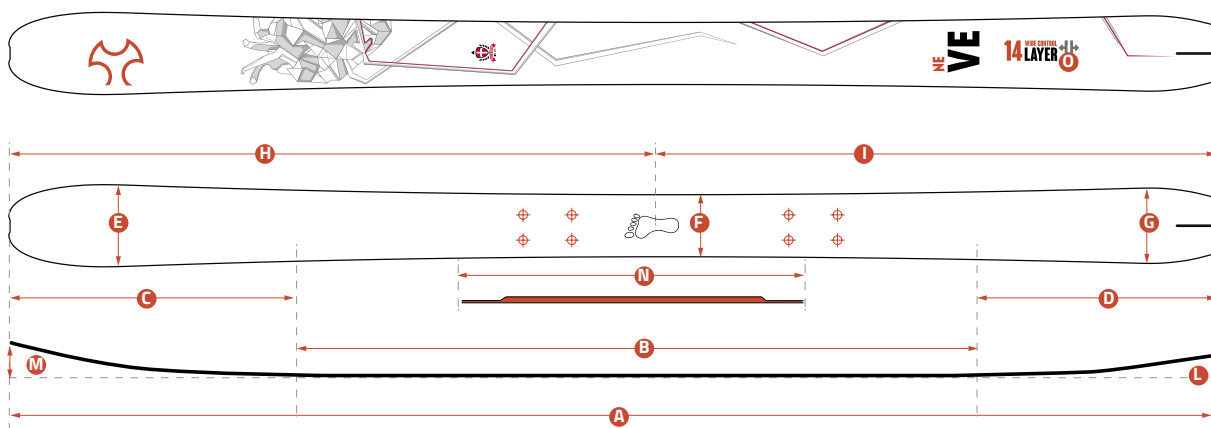

SKI TRAB NEVE	BENEFIT:	FLOATATION	CONTROL	RELIABILITY
<b>A</b> LENGTH	1810 mm	■	■	
<b>B</b> CAMBER	1240 mm		■	
<b>C</b> RAISED TIP	330 mm	■		
<b>D</b> RAISED TAIL	240 mm	■		
<b>E</b> TIP WIDTH	123 mm	■		
<b>F</b> CENTER WIDTH	93 mm	■	■	
<b>G</b> TAIL WIDTH	113 mm	■		
<b>H</b> DISTANCE TIP/BOOT CENTER	998 mm		■	
<b>I</b> DISTANCE TAIL/BOOT CENTER	812 mm		■	
<b>L</b> TAIL HEIGHT	13 mm		■	
<b>M</b> TIP HEIGHT	58 mm		■	
<b>N</b> NO SHOCK EDGE BOOST	400 mm		■	■
RADIUS	24.5 m		■	
WEIGHT	1460 g			■
<b>O</b> 14-LAYER WIDE CONTROL			■	■

## SUPPORTIVE FLEX

NEVE SUPPORTIVE FLEX

### NEVE SUPPORTIVE FLEX

La punta lunga e bassa è progettata per essere caricata in fase di discesa conferendo così allo sci una sciabilità eccezionale grazie alla sua forza. Nella zona più arretrata lo sci ha un flex più accentuato e permette in fase di carico di far lavorare maggiormente il raggio dello sci migliorandone la conducibilità ed il controllo. La zona di montaggio è stata avanzata in modo da migliorare l'assetto sullo sci.

*The long, low tip is designed to take weight in descent, giving the ski excellent maneuverability thanks to its strength. To the back of the ski there is a more accentuated flex, which during the loading phase makes the radius work harder, increasing steering and control. The mounting point has been moved forward to improve the weight distribution of the ski.*

## NOSHOCK EDGE BOOST

EDGE SUPPORT CONSTRUCTION

### NO SHOCK EDGE BOOST

Striscia di elastomero con rinforzo in fibra di vetro viene posta longitudinalmente tra le lamine nella parte centrale dello sci.

Crea un ulteriore supporto alle lamine nella parte più sottoposta a stress.

*A strip of fibreglass reinforced elastomer lies lengthways between the edges in the central part of the ski, creating extra support for the edges in the area most exposed to stress.*

# RACE TOURING BINDINGS

---



**THE BINDING OF THE CHAMPIONS!**  
**LIGHTWEIGHT**  
**RELIABLE**  
**EASY TO USE**



# TITAN GARA



LEVA ANTERIORE  
BLOCCO/SBLOCCO ATTACCO  
IN TECNOPOLIMERO  
*TECHNOPOLYMER*  
LOCK/UNLOCK FRONT LEVER



MOLLA A U IN TITANIO  
*TITANIUM SPRING*

ALETTE FORGIATE IN ALLUMINIO  
*FORGED ALUMINIUM JAWS*

PIN IN ACCIAIO TEMPRATO ROTORIBATTUTO  
*ROTO-RIVETED HARDENED STEEL PIN*

SKISTOPPER  
65mm



CAMBIO MODALITA' SALITA-DISCESA FACILE E VELOCE  
*EASY AND INTUITIVE TO SWITCH FROM UPHILL TOURING TO DOWNHILL SKIING MODE*



  
TITANIUM CORE  
▼

  
ELASTIC TITANIUM CORE  
▼

  
360° TECHNOLOGY  
▼

  
ZERO AND CLICK  
▼

  
STOPPER ZERO  
▼

  
ROTORIVETED PINS  
▼



## TITANIUM CORE

Un solo e semplice elemento in titanio particolarmente studiato nella sua forma e geometria collega le due ganasce del puntale. Questo meccanismo così semplice fornisce una importante garanzia di funzionalità e di affidabilità. L'apertura delle ganasce del puntale avviene con una facile pressione della leva anteriore, è possibile agire su quest'ultima con la mano o con il bastoncino. Nel momento in cui le spine delle ganasce sono allineate con i fori dello scarpone basta rilasciare la leva e le ganasce si chiudono bloccando la punta dello scarpone. Con la mano si ruota la stessa leva verso l'alto per bloccare l'apertura delle ganasce. Il particolare elemento elastico di titanio permette al puntale di adeguarsi perfettamente a tutti i tipi di scarponi, garantisce un ottimo bloccaggio dello scarpone e con l'aiuto di spine particolarmente rifinite e lavorate riesce a ripulire il foro scarpone durante l'uso.

*One simple component in titanium specially designed in its shape and structure links the two jaws in the toe unit. This extremely simple mechanism offers a significant guarantee of functionality and reliability. The toe unit jaws open with a light pressure on the front lever, which can be pressed either by hand or with a ski pole. Position the boot so that the jaw pins are level with the holes on the side of the boot, then release the lever so the jaws close locking the toe of the boot into place. Rotate the lever upwards to block the opening of the jaws. This special elastic component in titanium permits the toe unit to adapt perfectly to all types of boots, guarantees that the boot remains fixed in place and with the help of some particularly well finished and crafted pins it can clean out the boot inserts during use.*

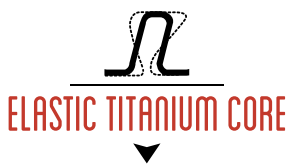

## ELASTIC TITANIUM CORE

L'elemento elastico in titanio (molla a filo sagomata) assicura al sistema un'importante elasticità che permette all'attacco di assorbire gli impatti dovuti a cadute. In questo modo gli elementi dell'attacco, l'ancoraggio allo sci o lo stesso sciatore subiscono un colpo/stress assorbito dall'elasticità del sistema e non uno strappo violento in caso di urto o caduta.

*The titanium elastic element (shaped wire spring) ensures remarkable elasticity that allows the binding to absorb the impact of falls. In this way the binding parts, the ski and the skiers themselves experience a hit that has been absorbed by the elasticity of the system and not a violent blow in case of a bump or fall.*



## ROTO-RIVETED PINS

Inserti scarpone del puntale in acciaio temperato con incavo autopulente. Roto rivettatura per ancoraggio stabile e duraturo.

*Boot pins of the front unit made of hardened steel with self-cleaning hollow. Roto-riveting for a steady and durable anchorage.*



## ZERO AND CLICK

La talloniera ha un innovativo sistema a scatto che permette un facile passaggio dalla posizione di salita a quella di discesa, inoltre la talloniera può essere ruotata di 90° permettendo in fase di salita l'appoggio dello scarpone sul piano dello sci migliorando la lunghezza del passo (angolo 0°).

*The heel unit has an innovative snap system that allows an easy transition from an uphill (5.7° angle) to a downhill position and can be rotated 90° allowing the boot to rest on the ski when moving uphill improving the length of stride (0° angle).*



## STOPPER ZERO

Lo stopper ha un innovativo sistema a scatto che permette un facile passaggio dalla posizione di salita a quella di discesa.

*The stopper has an innovative snap system that allows an easy transition from an uphill to a downhill position.*



## 360° TECHNOLOGY

Un attacco semplice ma che utilizza la sintesi di diverse tecnologie di lavorazione del leggero: forgiatura dell'alluminio, fresatura acciaio /alluminio, stampaggio polimeri speciali, lavorazioni e trattamenti del titanio.

*A simple binding which is nevertheless the synthesis of different lightweight processing technologies: aluminium forging, steel/aluminium milling, special polymer molding, titanium processing and treatments.*



## NEW TITAN GARA WORLD CUP

+ STOPPER - COD. 40289 - STOPPER COD. 40298

THE GARA TITAN BINDING HAS AN INNOVATIVE TOE UNIT OF ONE SIMPLE COMPONENT IN TITANIUM. ELASTICITY, STRENGTH AND INDEPENDENCE CHARACTERISE THIS ULTRA-LIGHTWEIGHT BINDING. THE HEEL UNIT HAS AN INNOVATIVE SNAP SYSTEM THAT ALLOWS AN EASY TRANSITION FROM AN UPHILL TO A DOWNHILL POSITION AND CAN BE ROTATED 90°. LIGHTER VERSION WITH U SPRING IN TITANIUM. NO-FRICTION SKI BRAKES. CRAMPON ATTACHMENT NOT INCLUDED.

↓ ↑	<b>Ski brake</b>	46 gr
↓ ↓	<b>Weight</b>	148 gr
↘	<b>Downhill angle</b>	0.7°
↗	<b>Uphill angle</b>	0° - 6°
↔	<b>Heel setting</b>	No setting
⊗ ⊗	<b>Material</b>	Ergal - Titanium - Steel -Technopolymer Titanium
↑ ↓	<b>Release</b>	TITAN SPRING



## NEW TITAN GARA

+ STOPPER - COD. 40297 - STOPPER COD. 40298

THE GARA TITAN BINDING HAS AN INNOVATIVE TOE UNIT OF ONE SIMPLE COMPONENT IN TITANIUM. ELASTICITY, STRENGTH AND INDEPENDENCE CHARACTERISE THIS ULTRA-LIGHTWEIGHT BINDING. THE HEEL UNIT HAS AN INNOVATIVE SNAP SYSTEM THAT ALLOWS AN EASY TRANSITION FROM AN UPHILL TO A DOWNHILL POSITION AND CAN BE ROTATED 90°. NO-FRICTION SKI BRAKES. CRAMPON ATTACHMENT INCLUDED.

↓ ↑	<b>Ski brake</b>	46 gr
↓ ↓	<b>Weight</b>	5.0 - 160gr / 4.5 - 4.0 - 159 gr
↘	<b>Downhill angle</b>	0.7°
↗	<b>Uphill angle</b>	0° - 6°
↔	<b>Heel setting</b>	No setting
⊗ ⊗	<b>Material</b>	Ergal - Titanium - Steel -Technopolymer Titanium
↑ ↓	<b>Release</b>	5.0 - 4.5 - 4.0



## TITAN GARA WORLD CUP

COD. 40236.BLU

THE GARA TITAN BINDING HAS AN INNOVATIVE TOE UNIT OF ONE SIMPLE COMPONENT IN TITANIUM. ELASTICITY, STRENGTH AND INDEPENDENCE CHARACTERISE THIS ULTRA-LIGHTWEIGHT BINDING. THE HEEL UNIT HAS AN INNOVATIVE SNAP SYSTEM THAT ALLOWS AN EASY TRANSITION FROM AN UPHILL TO A DOWNHILL POSITION AND CAN BE ROTATED 90°. LIGHTER VERSION WITH U SPRING IN TITANIUM. CRAMPON ATTACHMENT NOT INCLUDED.

↓ ↑	<b>Ski brake</b>	NO SKI BRAKE
↓ ↓	<b>Weight</b>	108 gr
↘	<b>Downhill angle</b>	0.7°
↗	<b>Uphill angle</b>	0° - 6°
↔	<b>Heel setting</b>	No setting
⊗ ⊗	<b>Material</b>	Ergal - Titanium - Steel -Technopolymer Titanium
↑ ↓	<b>Release</b>	TITAN SPRING



## TITAN GARA COD. 40237.BLU

THE GARA TITAN BINDING HAS AN INNOVATIVE TOE UNIT OF ONE SIMPLE COMPONENT IN TITANIUM. ELASTICITY, STRENGTH AND INDEPENDENCE CHARACTERISE THIS ULTRA-LIGHTWEIGHT BINDING. THE HEEL UNIT HAS AN INNOVATIVE SNAP SYSTEM THAT ALLOWS AN EASY TRANSITION FROM AN UPHILL TO A DOWNHILL POSITION AND CAN BE ROTATED 90°. CRAMPON ATTACHMENT INCLUDED.

↓ ↑	<b>Ski brake</b>	NO SKI BRAKE
↓ ↓	<b>Weight</b>	5.0 - 120 gr / 4.5 - 4.0 - 119 gr
↘	<b>Downhill angle</b>	0.7°
↗	<b>Uphill angle</b>	0° - 6°
↔	<b>Heel setting</b>	No setting
⊗ ⊗	<b>Material</b>	Ergal - Titanium - Steel -Technopolymer Titanium
↑ ↓	<b>Release</b>	5.0 - 4.5 - 4.0

# TOURING BINDINGS

---



**INNOVATION**  
**LIGHTWEIGHT**  
**QUALITY OF RELEASE**

# TITAN VARIO.2



CAMBIO MODALITA' SALITA-DISCESA FACILE E VELOCE  
*EASY AND INTUITIVE TO SWITCH FROM UPHILL TOURING TO DOWNHILL  
 SKIING MODE*



ALZATACCO CON 3 POSIZIONI  
*3 POSITION CLIMBING AID*

REGOLAZIONE 24 MM  
*ADJUSTMENT: 24 MM*



BASE ATTACCO CON CARRELLO SCORREVOLE ELASTICO PER  
 GARANTIRE SGANCIO LATERALE IN OGNI SITUAZIONE  
*BMM ELASTIC SLIDER TRACK TO IMPROVE RELEASE STANDARDS*

SKISTOPPER CON SISTEMA ANTIFRIZIONE  
**NO FRICTION MECHANISM**  
 78 mm / 85 mm / 94 mm

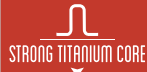

# FRONT UNIT

FORZA E INDIPENDENZA DELLE GANASCE TITAN RIDUCONO IL RISCHIO DI PERDERE LO SCI IN MANIERA ACCIDENTALE. IL SISTEMA TITAN PERMETTE ALLE GANASCE DI LAVORARE INDIPENDENTEMENTE UNA DALL'ALTRA.

THE STRENGTH AND INDEPENDENCE OF THE TITAN JAWS REDUCE THE RISK OF LOSING THE SKIS ACCIDENTALLY. THE TITAN SYSTEM ALLOWS THE JAWS TO WORK INDEPENDENTLY OF EACH OTHER.

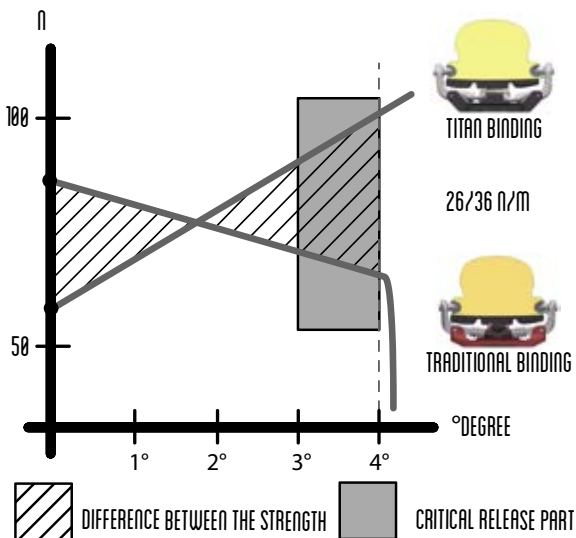

ALL' AUMENTARE DELLA SPINTA LATERALE CRESCE LA TENUTA DELLE GANASCE  
WHEN LATERAL PRESSURE INCREASES, SO DOES THE GRIP OF THE JAWS

Comparison between the release STRENGTHS of the Titan toe unit and a toe unit with traditional system

# BACK UNIT

## ELASTICITY

E' NECESSARIO UN SISTEMA CHE ASSORBA I PICCHI DI FORZA (VIBRAZIONI E IMPATTI) IN FASE DI SCIATA. PER LA TALLONIERA SONO NECESSARI UN ANGOLO E UNA FORZA ELASTICA (MINIMO 36°) IN GRADO DI RIPORTARE LO SCARPONE IN POSIZIONE CENTRALE.

WE NEED A SYSTEM CAPABLE OF ABSORBING SHOCKS (VIBRATIONS AND IMPACTS) WHEN SKIING. AS REGARDS THE HEEL UNIT WE NEED AN ANGLE AND AN ELASTIC STRENGTH (MIN. 36°) ABLE TO REPOSITION THE SKI BOOT IN A CENTRAL POSITON.

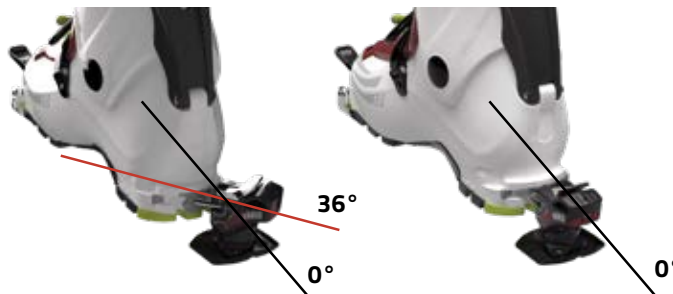

## FRONTAL AND LATERAL RELEASE

TUTTI GLI ATTACCHI DEVONO AVERE SGANCI FRONTALI E LATERALI IN CASO DI CADUTA. ALL SKI BINDINGS SHOULD HAVE FRONT AND LATERAL RELEASE SYSTEMS IN CASE OF A FALL.



## SLIDER TRACK 8 MM

IN CASO DI FLESSIONE DELLO SCI, UNA TALLONIERA FISSA NON PERMETTE LO SGANCIO LATERALE IN POSIZIONE DI SCI FLESSO. E' NECESSARIO CHE L'ATTACCO POSSA MUOVERSI SU UN CARRELLO PER FAR SÌ CHE LO SGANCIO LATERALE NON VENGA COMPROMESSO.

IN CASE OF SKI FLEXION, A FIXED HEEL UNIT DOES NOT ALLOW A LATERAL RELEASE IN A POSITION OF FLEXED SKI. IT IS NECESSARY THAT THE SKI BINDING CAN MOVE ON A TRACK SO THAT THE LATERAL RELEASE IS NOT PUT IN JEOPARDY.



## SKISTOPPER NO FRICTION

LA FORZA DI SGANCIO DELLO SCARPONE NON DEVE ESSERE INFLUENZATA DALLO SKISTOPPER. IL SISTEMA NO-FRICTION PERMETTE DI TOGLIERE ATTRITI E FRIZIONI IN CASO DI SGANCIO LATERALE.

THE RELEASE STRENGTH OF THE SKI BOOT SHOULD NOT BE INFLUENCED BY THE SKI BRAKE. THE NO-FRICTION SYSTEM ALLOWS TO REMOVE ANY FRICTION OR RUBBING IN CASE OF A LATERAL RELEASE.

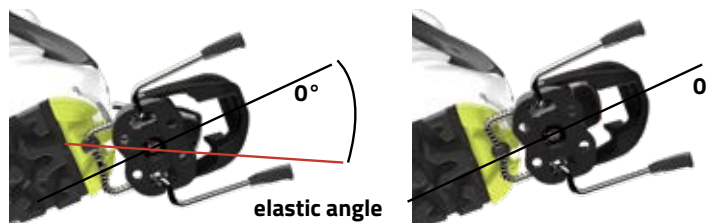



TITANIUM CORE

## TITANIUM CORE

Un solo e semplice elemento in titanio particolarmente studiato nella sua forma e geometria collega le due ganasce del puntale. Questo meccanismo così semplice fornisce una importante garanzia di funzionalità e di affidabilità. L'apertura delle ganasce del puntale avviene con una facile pressione della leva anteriore, è possibile agire su quest'ultima con la mano o con il bastoncino. Nel momento in cui le spine delle ganasce sono allineate con i fori dello scarpone basta rilasciare la leva e le ganasce si chiudono bloccando la punta dello scarpone. Con la mano si ruota la stessa leva verso l'alto per bloccare l'apertura delle ganasce. Il particolare elemento elastico di titanio permette al puntale di adeguarsi perfettamente a tutti i tipi di scarponi, garantisce un ottimo bloccaggio dello scarpone e con l'aiuto di spine particolarmente rifinite e lavorate riesce a ripulire il foro scarpone durante l'uso.

*One simple component in titanium specially designed in its shape and structure links the two jaws in the toe unit. This extremely simple mechanism offers a significant guarantee of functionality and reliability. The toe unit jaws open with a light pressure on the front lever, which can be pressed either by hand or with a ski pole. Position the boot so that the jaw pins are level with the holes on the side of the boot, then release the lever so the jaws close locking the toe of the boot into place. Rotate the lever upwards to block the opening of the jaws. This special elastic component in titanium permits the toe unit to adapt perfectly to all types of boots, guarantees that the boot remains fixed in place and with the help of some particularly well finished and crafted pins it can clean out the boot inserts during use.*



ELASTIC TITANIUM CORE

## ELASTIC TITANIUM CORE

L'elemento elastico in titanio (molla a filo sagomata) assicura al sistema un'importante elasticità che permette all'attacco di assorbire gli impatti dovuti a cadute. In questo modo gli elementi dell'attacco, l'ancoraggio allo sci o lo stesso sciatore subiscono un colpo/stress assorbito dall'elasticità del sistema e non uno strappo violento in caso di urto o caduta.

*The titanium elastic element (shaped wire spring) ensures remarkable elasticity that allows the binding to absorb the impact of falls. In this way the binding parts, the ski and the skiers themselves experience a hit that has been absorbed by the elasticity of the system and not a violent blow in case of a bump or fall.*



ROTORIVETED PINS

## ROTO-RIVETED PINS

Inserti scarpone del puntale in acciaio temperato con incavo autopulente. Roto rivettatura per ancoraggio stabile e duraturo.

*Boot pins of the front unit made of hardened steel with self-cleaning hollow. Roto-riveting for a steady and durable anchorage.*



ZERO AND CLICK

## ZERO AND CLICK

La talloniera ha un innovativo sistema a scatto che permette un facile passaggio dalla posizione di salita a quella di discesa, inoltre la talloniera può essere ruotata di 90° permettendo in fase di salita l'appoggio dello scarpone sul piano dello sci migliorando la lunghezza del passo (angolo 0°).

*The heel unit has an innovative snap system that allows an easy transition from an uphill (5.7° angle) to a downhill position and can be rotated 90° allowing the boot to rest on the ski when moving uphill improving the length of stride (0° angle).*



LOW FRICTION

## LOW FRICTION

La forza di sgancio dello scarpone non deve essere influenzata dallo skistopper. Il sistema No-Friction permette di togliere attriti e frizioni in caso di sgancio laterale.

*The release strength of the ski boot should not be influenced by the ski brake. The No-Friction System allows to remove any friction or rubbing in case of a lateral release.*



360° TECHNOLOGY

## 360° TECHNOLOGY

Un attacco semplice ma che utilizza la sintesi di diverse tecnologie di lavorazione del leggero: forgiatura dell'alluminio, fresatura acciaio /alluminio, stampaggio polimeri speciali, lavorazioni e trattamenti del titanio.

*A simple binding which is nevertheless the synthesis of different lightweight processing technologies: aluminium forging, steel/aluminium milling, special polymer molding, titanium processing and treatments.*



## FUNCTIONAL RELEASE

### FUNCTIONAL RELEASE

Non ci siamo fermati alla funzionalità e all' affidabilità ma abbiamo introdotto il concetto di sgancio funzionale: un'innovativa soluzione che permette allo sgancio laterale di assorbire i picchi di forza che si creano sciando in velocità e su nevi dure, vibrazioni importanti che potrebbero far sganciare l'attacco. Solo con questo accorgimento possiamo consigliare di sciare con l'attacco predisposto in posizione di discesa rendendo quindi possibile il funzionamento degli sganci frontali e laterali in caso di caduta.

*We didn't stop at functionality and reliability, but introduced the concept of functional release: an innovative solution that allows the side release to absorb peak force created by skiing fast on hard snow, large vibrations that could cause the binding to release. It is thanks to this development that we are able to recommend skiing with the binding pre-fitted in a downhill position making it therefore possible for the front and side releases to work in case of a fall.*



## INDEPENDENT JAWS

### INDEPENDENT TITANIUM JAWS

Il sistema Titan permette alla ganasce di avere una certa indipendenza tra di loro, al contrario di quelli a pin tradizionale in cui entrambe le ganasce si muovono simmetricamente, che riduce la possibilità di svicolo accidentale. La presa dello scarpone risulta in questo modo molto più performante e sicura.

*The Titan system allows the jaws to work independently of each other, unlike a traditional pin system where the jaws move symmetrically, reducing the chance of accidental release. The boot hold is therefore more effective and safe.*



## STRONG TITANIUM CORE

### STRONG TITANIUM JAWS

La molla a filo in titanio sagomata offre una resistenza incrementale in fase sgancio, al contrario del sistema tradizionale che perde forza mentre si apre, questo fa sì che la presa e la tenuta dello scarpone è molto più elevata rispetto ai classici attacchi e permette di scegliere anche durante la camminata di avere la possibilità di sgancio attacco o blocco.

*The shaped titanium wire spring ensures increased strength when releasing the binding. Unlike the traditional system that loses strength when opening, this means that the grip of the boot is much better compared to classic bindings and lets the skier decide even when walking to release or block the binding.*



## TITAN VARIO.2

**COD. 40290B Blue - COD. 40290R Red**

THE VARIO.2 BINDING HAS AN INNOVATIVE TOE UNIT OF ONE SIMPLE COMPONENT IN TITANIUM. ELASTICITY, STRENGTH AND INDEPENDENCE CHARACTERISE THIS ULTRA-LIGHTWEIGHT BINDING. THE HEEL UNIT OFFERS DIFFERENT SOLUTIONS IMPROVING THE QUALITY OF RELEASE: LATERAL ELASTICITY TILL 43°, 8MM ELASTIC SLIDER TRACK, COMPATIBLE FRONT AND SIDE RELEASES.

↓ ↑	<b>Ski brake</b>	NO SKI BRAKE
↓ ↓	<b>Weight</b>	250 gr
↘	<b>Downhill angle</b>	2.8°
↗	<b>Uphill angle</b>	0° 8.7° 10.5°
↔	<b>Heel setting</b>	24 mm
⊗ ⊗	<b>Material</b>	Ergal - Titanium - Steel - Technopolymer
↗ ↘	<b>Release</b>	5-7      7-9      9-11

REGOLAZIONE SGANCIO FRONTALE E LATERALE 5-7 7-9 9-11  
FRONT AND LATERAL RELEASE SETTING 5-7 7-9 9-11







## TITAN VARIO.2 + STOPPER

COD. 40291B Blue - COD. 40291R Red

THE VARIO.2 BINDING HAS AN INNOVATIVE TOE UNIT OF ONE SIMPLE COMPONENT IN TITANIUM. ELASTICITY, STRENGTH AND INDEPENDENCE CHARACTERISE THIS ULTRA-LIGHTWEIGHT BINDING. THE HEEL UNIT OFFERS DIFFERENT SOLUTIONS IMPROVING THE QUALITY OF RELEASE: LATERAL ELASTICITY TILL 43°, 8MM ELASTIC SLIDER TRACK, COMPATIBLE FRONT AND SIDE RELEASES, NO-FRICTION SKI BRAKES..

↓ ↑	<b>Ski brake</b>	mm.65	mm.78	mm.85	mm.94
↓ ↓	<b>Weight</b>	309 gr			
↘	<b>Downhill angle</b>	2.9°			
↗	<b>Uphill angle</b>	5.8° 8.8° 10.6°			
↔	<b>Heel setting</b>	24 mm			
⊗	<b>Material</b>	Ergal - Titanium - Steel Technopolymer			
↕	<b>Release</b>	5-7	7-9	9-11	



## TITAN VARIO.2 KID + STOPPER

Titan Vario.2 Kid - COD. 40295

THE VARIO.2 BINDING HAS AN INNOVATIVE TOE UNIT OF ONE SIMPLE COMPONENT IN TITANIUM. ELASTICITY, STRENGTH AND INDEPENDENCE CHARACTERISE THIS ULTRA-LIGHTWEIGHT BINDING. THE HEEL UNIT OFFERS DIFFERENT SOLUTIONS IMPROVING THE QUALITY OF RELEASE: LATERAL ELASTICITY TILL 43°, 8MM ELASTIC SLIDER TRACK, COMPATIBLE FRONT AND SIDE RELEASES, NO-FRICTION SKI BRAKES..

↔	<b>Heel setting</b>	24 mm
⊗	<b>Material</b>	Ergal - Titanium - Steel Technopolymer
↕	<b>Release</b>	2-4
↓ ↑	<b>Ski brake</b>	mm.78
↓ ↓	<b>Weight</b>	309 gr
↘	<b>Downhill angle</b>	2.9°
↗	<b>Uphill angle</b>	5.8° 8.8° 10.6°



## TITAN VARIO.2 RENTAL

COD. 40292B Blue - COD. 40292R Red

THE VARIO.2 RENTAL BINDING HAS AN INNOVATIVE TOE UNIT OF ONE SIMPLE COMPONENT IN TITANIUM. ELASTICITY, STRENGTH AND INDEPENDENCE CHARACTERISE THIS ULTRA-LIGHTWEIGHT BINDING. THE HEEL UNIT OFFERS DIFFERENT SOLUTIONS IMPROVING THE QUALITY OF RELEASE: LATERAL ELASTICITY TILL 43°, 8MM ELASTIC SLIDER TRACK, COMPATIBLE FRONT AND SIDE RELEASES.

↓ ↑	<b>Ski brake</b>	NO SKI BRAKE
↓ ±	<b>Weight</b>	255 gr
↘	<b>Downhill angle</b>	2.8°
↗	<b>Uphill angle</b>	0° 8.7° 10.5°
↔	<b>Heel setting</b>	34 mm
↔	<b>Material</b>	Ergal - Titanium - Steel - Technopolymer
↔	<b>Release</b>	5-7      7-9      9-11



## TITAN VARIO.2 RENTAL+STOPPER

COD. 40293B Blue - COD. 40293R Red

THE VARIO.2 RENTAL BINDING HAS AN INNOVATIVE TOE UNIT OF ONE SIMPLE COMPONENT IN TITANIUM. ELASTICITY, STRENGTH AND INDEPENDENCE CHARACTERISE THIS ULTRA-LIGHTWEIGHT BINDING. THE HEEL UNIT OFFERS DIFFERENT SOLUTIONS IMPROVING THE QUALITY OF RELEASE: LATERAL ELASTICITY TILL 43°, 8MM ELASTIC SLIDER TRACK, COMPATIBLE FRONT AND SIDE RELEASES, NO-FRICTION SKI BRAKES. HEEL SETTING 34MM.

↓ ↑	<b>Ski brake</b>	mm.65	mm.78	mm.85	mm.94
↓ ±	<b>Weight</b>	315 gr			
↘	<b>Downhill angle</b>	2.9°			
↗	<b>Uphill angle</b>	5.8° 8.8° 10.6°			
↔	<b>Heel setting</b>	34 mm			
↔	<b>Material</b>	Ergal - Titanium - Steel Technopolymer			
↔	<b>Release</b>	5-7	7-9	9-11	



## RAMPANT

Rampante in alluminio con aggancio standard.  
*Alloy rampant with standard attachment.*

**COD. 40275** SIZE: 75mm - 86mm - 91mm - 97 mm

**COD. 40303** SIZE: 102mm - 108mm - 120mm



## VARIO SKI STOPPER - COD. 40283

Nuovo Ski stopper leggerissimo (pesa solo 62gr) e funzionale. Protetto da due brevetti internazionali, i cui punti chiave sono:  
1. il tallone dello scarpone poggia su una ruota che accompagna il movimento laterale del tallone durante lo sgancio senza causare alcun attrito. Questo meccanismo non influisce sul valore di sgancio laterale.  
2. Leva dello ski stopper con funzione di bloccaggio e alzataccco.  
*New lightweight ski brake (it weighs only 62 gr) and functional. Exclusive and patented operating system of the ski stopper.*

*Key points of the patent:*

- 1. The ski stopper is held down with the heel of the boot by means of a wheel, capable of turning and translating freely. The wheel accompanies the lateral movement of the heel during the release without causing any friction. This mechanism does not affect the lateral release value.*
- 2. Multifunctional locking lever: ski stopper locking system and climbing-aid.*

SIZE: 78mm - 85mm - 94 mm



**MASCHERA MONTAGGIO TITAN**  
**TITAN MOUNTING JIG** - Cod. 40270

## PLATE VARIO - COD. 40271

Piastra leggerissima (solo 57gr) che consente la regolazione dell'attacco fino a 24 mm. Un carrello scorrevole permette di mantenere costanti gli standard di sgancio.

*Really lightweight plate (only 57g) that allows to adjust the size till 24mm. A slider track permits to maintain constant release standards.*

## VARIO RENTAL PLATE - COD. 40281

Piastra leggerissima (solo 62gr) che consente la regolazione dell'attacco fino a 34 mm. Un carrello scorrevole permette di mantenere costanti gli standard di sgancio.

*Really lightweight plate (only 62g) that allows to adjust the size till 34mm. A slider track permits to maintain constant release standards.*



## ERGAL GARA TITAN PLATE - COD. 40265

60 mm



## LACCETTO/COIL LEASH - COD. 40230

Laccetto per fissare lo sci allo scarpone in assenza di skistopper. Con moschettone personalizzato ski trab.  
*Safety leash to attach the ski to the boot if not equipped with ski brakes (with SKI TRAB customized carabiner).*



**FREETOURING BINDINGS**

**TR1**

**A REAL BINDING**



**POWERFUL . EFFICIENT . PRACTICAL**

**A SKI BINDING THAT OFFERS MAXIMUM CONTROL IN DESCENT  
HIGH-PERFORMING, EASY TO USE IN ALL UPHILL CONDITIONS**

# TRI . A REAL BINDING



VARIAZIONE ALZATACCO SEMPLICE ED VELOCE  
QUICK AND INTUITIVE SETTING OF CLIMBING-AID POSITIONS



SGANCIO FRONTALE 6-13  
FRONT RELEASE SETTING 6-13

GANASCIA POSTERIORE IN ACCIAIO  
STEEL BACK JAW

CARRELLO SCORREVOLE 12mm  
ELASTIC SLIDER TRACK 12 mm

REGOLAZIONE 21 mm  
21 mm ADJUSTMENT

MASSIMO CONTROLLO GRAZIE ALLA MINIMA  
Distanza tra sci e scarpone  
MAXIMUM CONTROL THANKS TO THE MINIMAL  
DISTANCE BETWEEN SKI/SKI BOOT (24mm)



BLOCCO/SBLOCCO LEVA FRONTALE  
LOCK/UNLOCK FRONT LEVER

BASE EXTRA LARGA  
EXTRA-WIDE BASE

SGANCIO LATERALE 6-13  
SIDE RELEASE SETTING 6-13



  
**RELIABILITY**  
STRONG METAL STRUCTURE

# TRI . A REAL BINDING

## POWERFUL, EFFICIENT, PRACTICAL.

A TOURING SKI BINDING THAT OFFERS MAXIMUM CONTROL IN DESCENT: EFFICIENT AND PRACTICAL EVEN IN EXTREME CONDITIONS.

THE FORCE GENERATED BY THE METAL STRUCTURE GRIPS THE BOOT FIRMLY TO THE SKI, ELIMINATING THE SLIPPAGE COMMON WITH TRADITIONAL PIN BINDING SYSTEMS WHERE THERE IS SPACE BETWEEN THE HEEL AND THE SKI.

THE BOND BETWEEN BOOT AND SKI ENSURES IMMEDIATE POWER TRANSMISSION, MAXIMISING CONTROL AND RESPONSIVENESS.

THE RELEASE SYSTEMS, LATERAL ON THE TOE PIECE AND FRONTAL ON THE HEEL PIECE, BOTH ADJUSTABLE, ARE EXTREMELY POWERFUL AND EFFICIENT.

THE INCREMENTAL CLAMPING FORCE OF THE TOE PIECE ALLOWS THE SKIER TO WALK EVEN WHEN THE LEVER IS UNLOCKED, RELEASING THE SKI IN CASE OF AVALANCHE. THE ABILITY TO LOCK THE TOE PIECE IN ICY CONDITIONS OR UNLOCK IT IN CASE OF UNSTABLE SNOW IS ESSENTIAL FOR SAFE SKIING.

THE BRAKE IS AUTOMATICALLY ACTIVATED IN BOTH DOWNHILL AND UPHILL MODE.

EASY AND INTUITIVE TO OPERATE. USING JUST A POLE, WITHOUT RELEASING THE BOOT, IT IS POSSIBLE TO SWITCH FROM UPHILL TO DOWNHILL MODE AND VICE VERSA. ESSENTIAL FOR MAINTAINING CONTROL EVEN IN DIFFICULT CONDITIONS.

## FORTE, EFFICACE, FUNZIONALE.

UN ATTACCO DA SCI-ALPINISMO SVILUPPATO PER AVERE IL MASSIMO CONTROLLO IN DISCESA, EFFICACE E FUNZIONALE ANCHE IN SITUAZIONI ESTREME.

LA FORZA GENERATA DALLA STRUTTURA IN METALLO TIENE PREMUTO LO SCARPONE CONTRO LO SCI AZZERANDO LE PERDITE TIPICHE DEI SISTEMI TRADIZIONALI CON TACCO IN SOSPENSIONE.

IL BLOCCAGGIO A CONTATTO DI SCI E SCARPONI RENDE IMMEDIATA LA TRASMISSIONE DEGLI IMPULSI, MASSIMIZZANDO IL CONTROLLO E LA RISPOSTA AI COMANDI.

GLI SGANCI DI SICUREZZA, LATERALI SUL PUNTALE E FRONTALI SULLA TALLONIERA, ENTRAMBI REGOLABILI, SONO ESTREMAMENTE FORTI ED EFFICACI.

LA FORZA INCREMENTALE DI SERRAGGIO DEL PUNTALE PERMETTE LA CAMMINATA ANCHE A LEVA SBLOCCATA, CONSENTENDO LO SGANCIO DELLO SCI IN CASO DI VALANGA.

BLOCCARE IL PUNTALE SUL GHIACCIO O SBOCCARLO IN CASO DI NEVE INSTABILE SONO ASPETTI FONDAMENTALI PER LA PRATICA IN SICUREZZA.

STOPPER AD ATTIVAZIONE AUTOMATICA SU ENTRAMBE LE CONFIGURAZIONI DI SALITA E DISCESA.

CALZATA FUNZIONALE E SEMPLICITÀ NEI CAMBI DI ASSETTO. CON IL SOLO USO DEL BASTONE, E SENZA SVINCOLARE LO SCARPONE, SI PASSA DALLA MODALITÀ DI SALITA A QUELLA DI DISCESA E VICEVERSA. ESSENZIALE PER IL MANTENIMENTO DEL CONTROLLO ANCHE IN CONDIZIONI LIMITE.

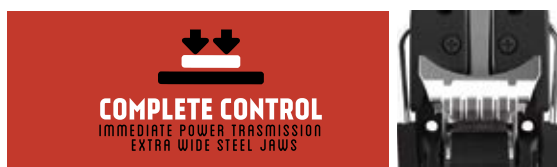

**COMPLETE CONTROL**  
IMMEDIATE POWER TRANSMISSION  
EXTRA WIDE STEEL JAWS



**TRASMISSIONE DELLA FORZA IMMEDIATA**  
**IMMEDIATE POWER TRANSMISSION**  
**GANASCIA EXTRA LARGA IN ACCIAIO**  
**EXTRA WIDE STEEL JAWS**



**INCREMENTAL FORCE**  
ALLOWS TO WALK WITH THE LEVER OPEN

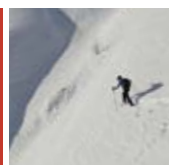

**CI PERMETTETE DI CAMMINARE CON LA LEVA APERTA**  
**ALLOWS TO WALK WITH THE LEVER OPEN**

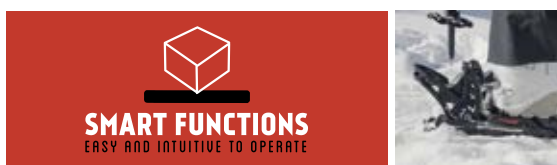

**SMART FUNCTIONS**  
EASY AND INTUITIVE TO OPERATE



**FACILE ED INTUITIVO DA UTILIZZARE**  
**EASY AND INTUITIVE TO OPERATE**



**QUALITY OF RELEASE**  
LATERAL/FRONTAL POWERFUL & EFFICIENT



**LATERALE/FRONTALE POTENTE ED EFFICIENTE**  
**LATERAL/FRONTAL POWERFUL AND EFFICIENT**



**RELIABILITY**  
STRONG METAL STRUCTURE



**STRUTTURA COMPLETAMENTE IN METALLO**  
**STRONG METAL STRUCTURE**



## TR1 - COD. 40301

↓ ↑	<b>Ski brake</b>	88 / 102 / 112 / 120 mm
↓ ↓	<b>Weight</b>	685 gr
↘	<b>Downhill angle</b>	2.6°
↗	<b>Uphill angle</b>	6° / 12°
↔	<b>Heel setting</b>	21 mm
↔	<b>Material</b>	6 - 13
↔	<b>Release</b>	6 - 13

MASCHERA MONTAGGIO TR1  
TR1 MOUNTING JIG - Cod. 40296



# SKI SKINS



## BRAND 100% MOHAIR SKINS TRADITIONAL HOT MELT GLUE

TESSILFOCA MOHAIR 100% CHE GARANTISCE UN'OTTIMA SCORREVOLEZZA E UNA BUONA TENUTA. CONFEZIONATA CON GANCIO PUNTA E GANCIO CODA ATTIVO DI SKI TRAB. COLORE PATTERN SKI TRAB. SISTEMA COLLANTE TRADIZIONALE HOTMELT. DISPONIBILE ANCHE IN ROTOLI DI DIVERSE LARGHEZZE.

100% MOHAIR CLIMBING SKINS THAT GUARANTEE EXCELLENT SLIDE AND GOOD GRIP.

COMPLETE WITH SKI TRAB ACTIVE TIP AND TAIL FASTENERS. NEW VERSION WITH SKI TRAB LOGO IN COLOUR. ALSO AVAILABLE IN ROLLS OF DIFFERENT WIDTHS. TRADITIONAL HOT MELT ADHESIVE SYSTEM.

**SKIN MOHAIR 76** cod 21125 - cod 21125AT

⌘ 150(AT)/157/164/171/178

**SKIN MOHAIR 85** cod 21126 - cod 21126AT

⌘ 150(AT)/157/164/171/178

**SKIN MOHAIR 90** Cod. 21131

⌘ 157/164/171/178

**SKIN MOHAIR 93** Cod. 21129

↔ 174/181/188

**MISTICO** Cod. 21122

↔ 157/164/171/178/185

**SUPERMAXIMO** Cod. 21123

↔ 171/178/185

**Features:** Attivo top fix+end hook Attivo+skin bag

**ROTOLO ROLLS 44MT** Cod. 21108B

↔ 85/100/110/120



GLIDING

GRIP

DURABILITY





## MIX 65% MOHAIR SKINS

TRADITIONAL HOT MELT GLUE

PELLE 65% MOHAIR PER UN OTTIMO GRIP E GRANDE DURABILITÀ. IL SISTEMA DI FISSAGGIO PUNTA E CODA ATTIVO PERMETTE UN COMODO E VELOCE MODO DI BLOCCAGGIO PELLE SULLO SCI. DISPONIBILE ANCHE IN ROTOLI DI DIVERSE LARGHEZZE. 65% MOHAIR CLIMBING SKIN FOR AN EXCELLENT GRIP AND DURABILITY. THE ATTIVO FIXING SYSTEM ALLOWS A COMFORTABLE AND QUICK FASTENING OF THE SKIN AT THE TIP AND TAIL OF THE SKI. ALSO AVAILABLE IN ROLLS OF DIFFERENT LENGTHS.

**MAXIMO** Cod. 21115

⌘ 157/164/171/178/185

**SUPERMAXIMO** Cod. 21116

⌘ 164/171/178/185

**SINTESI** Cod. 21112

⌘ 150/157/164/171/178

**ALTAVIA** Cod. 21113

⌘ 150/157/164/171/178

**SKIN MIX 76** Cod. 21127 - Cod. 21127AT

⌘ 150/157/164/171/178

**SKIN MIX 85** Cod. 21128 - Cod. 21128AT

⌘ 150/157/164/171/178

**SKIN MIX 90** Cod. 21130

⌘ 157/164/171/178

**SKIN MIX KID** Cod. 21132

⌘ 135

**Features:** Attivo top fix+endhook Attivo+skin bag

**ROTOLO - ROLLS MT. 44** Cod. 21022

↔ 35/75/85/100/110/120



GLIDING

GRIP

DURABILITY

**SKIN MIX UNIVERSAL ATTIVO**

Cod. 21133

⌘ 150/157/164/171/178

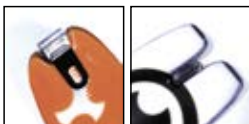

**SKIN MIX UNIVERSAL 100**

Cod. 21134

⌘ 150/160/170/180



**SKIN MIX UNIVERSAL 120**

Cod. 21135

⌘ 150/160/170/180



## RACE YELLOW SKINS

TRADITIONAL HOTMELT GLUE

TESSILFOCA DA GARA MOHAIR 100% - STUDIATA PER LE COMPETIZIONI PER LE SUE GRANDI DOTI DI SCORREVOLEZZA GARANTISCE OTTIME PERFORMANCE, CONFEZIONATA CON IL GANCIO PUNTA ATTIVO SKI TRAB - LEGGERISSIMO E DI FACILE E VELOCE UTILIZZO.

100% MOHAIR RACE CLIMBING SKINS - DESIGNED FOR COMPETITIONS IT GUARANTEES GREAT PERFORMANCE THANKS TO THE EXCELLENT GLIDE, MADE WITH SKI TRAB ACTIVE TIP FASTENER - LIGHTWEIGHT AND QUICK AND EASY TO USE.

**SKIN RACE 64** Cod. 21104

⌘ 157/164/171 cm

**Features:** Attivo top fix +skin bag

**SKIN RACE 76** Cod. 21125G

⌘ 157/164 /171/178

**SKIN RACE 85** Cod. 21126G

⌘ 157/164 /171/178

**Features:** Attivo top fix+endhook Attivo+skin bag

**ROTOLO - ROLLS RACE 33 MT** Cod. 21108

↔ 60/63/70/85/95



GLIDING

GRIP

DURABILITY

# SKINS ACCESSORIES

**GANCIO PUNTA +  
GANCIO CODA TOP FIX +  
END HOOK ATTIVO.2**  
cod 22063



**GANCIO PUNTA PELLI ATTIVO  
ATTIVO TOP FIX**  
Cod. 22046



**GANCIO CODA/END HOOK  
ATTIVO.2**  
Cod 22062



**GANCIO PUNTA + CODA  
TOP + END FIX ATTIVO**  
Cod. 22051



**GANCIO CODA ATTIVO  
ATTIVO TAIL FIX**  
Cod. 22048



**TIP FIX SET**  
Cod. 22069  
Size: 75/85/95/105 mm



**ANELLO METALLICO  
METAL RING**  
Cod. 22058  
Size: 75/85/95 mm



**SACCHETTO CUSTODIA  
SKI SKIN BAG**  
Cod. 22064



**ATTREZZO RIMUOVI COLLANTE  
GLUE SCRAPER**  
Cod. 22012



**RICAMBIO RIMUOVI COLLANTE  
BRASS SCRAPER**  
Cod. 22013



**COLLANTE SPRAY  
SPRAY GLUE 75 ML**  
Cod. 22014



**GANCIO CODA SQUALO  
SHARK END HOOK**  
Cod. 22053



**SCIOLINA PELLI STICK  
SKIN WAX STICK**  
Cod. 22056



**SCIOLINA FLUORO PURE  
PURE FLUORINATED SKIN WAX**  
Cod. 22057



**GANCIO CODA CON RIVETTI  
TAIL HOOK WITH RIVETS**  
Cod. 22020



**1 FILM PROTEZIONE COLLA  
1 GLUE PROTECTION FILM**  
Cod. 22018



**RETE PROTEZIONE  
COLLA NYLON  
NYLON MESH  
GLUE PROTECTION**  
Cod. 22052



**SET RIVETTI  
SET OF RIVETS 100 PCS.**  
Cod. 22034

**SET RIVETTI INOX  
SET OF INOX RIVETS 100 PCS.**  
Cod. 22059

**TAIL CLIP SET**  
Cod. 22054



**HYBRID CLEANING  
SPRAY 100 ML**  
Cod. 22067



**COLLANTE  
SKITRAB GLUE 65 G**  
Cod. 22002



**MASTRO COLLANTE  
GLUE TAPE**  
4 mt - 140mm - Cod. 22061  
50 mt / 140 mm - Cod. 22068



# SKI POLES



# ONE PIECE LIGHT POLES

## VERTICAL CARBON QC

Cod.41148

BASTONE IN CARBONIO PER COMPETIZIONI DA SCIALPINISMO. SPECIALE RINFORZO IN KEVLAR PER MIGLIORARE RIGIDITÀ E RESISTENZA.

*CARBON POLES FOR USE IN SKI MOUNTAINEERING RACES. SPECIAL KEVLAR REINFORCEMENT TO IMPROVE STIFFNESS AND RESISTANCE.*

Cod.42010 VERTICAL HANDLE

Cod.42012 VERTICAL STRAP

## 100% CARBON

Material: 100% Carbon  
 Strap: Vertical Strap  
 Handle: Vertical Handle  
 Basket: Gara QC basket+Widia  
 Size: 120cm-150cm each 5 cm  
 Weight: 160 gr 140cm

Cod.42043  
 BASKET GARA QC



Cod.42062  
 TIPS+BASKET  
 ORTLES QC



Cod.42044  
 BASKET TORNADO  
 BIG QC



Cod.42045  
 ROLLSKI TIP QC



KEVLAR  
 REINFORCEMENT



Cod.42042  
 BASE AND NUT QC



Cod.42043  
 BASKET GARA QC

# ONE PIECE LIGHT POLES



## GARA WORLD CUP QC

Cod.41146

BASTONE IN ERGAL LEGGERO CON MANOPOLA SUGHERO E PAPERA QUICK CHANGE  
 POLES MADE OF LIGHT ERGAL WITH CORK HANDLES AND QUICK CHANGE BASKETS.

Cod.42010 VERTICAL HANDLE

Cod.42012 VERTICAL STRAP

GRIP SUPPORT

Material: Ergal Ø 16x0.8  
 Strap: Vertical Strap  
 Handle: Vertical Handle  
 Basket: Gara QC basket+Widia  
 Size: 110cm-145 cm each 5 cm  
 Weight: 215 gr 130cm

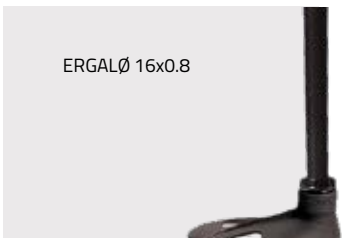
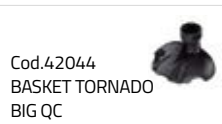
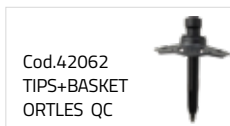

Cod.42042  
BASE AND NUT QC

Cod.42043  
BASKET GARA QC



## GARA Cod.41147

BASTONE IN ERGAL LEGGERO CON MANOPOLA GOMMA E PAPERA GARA.  
 POLES MADE OF LIGHT ERGAL WITH RUBBER HANDLES AND GARA BASKETS.

Cod.42036 RUBBER CLIP HANDLE

Cod.42033 ALP CLIP STRAP

Material: Ergal Ø 16x0.8  
 Strap: Alp Clip strap  
 Handle: Rubber clip handle  
 Basket: Rally basket+Widia  
 Size: 110cm-145cm each 5 cm  
 Weight: 210 gr 130cm

ERGAL Ø 16x0.8



Cod.42006  
BASKET SUPPORT

Cod.42005  
BASKET RALLY



# ONE PIECE TOURING POLES

## ORTLES CARBON Cod.41131

ORTLES È IL BASTONE AD ALTA AFFIDABILITÀ FISSO IN DISCESA E REGOLABILE IN SALITA. REALIZZATO IN CARBONIO HM HA UNA RIGIDITÀ E UNA FORZA IMPORTANTI. *ORTLES IS A RELIABLE POLE FIXED IN DESCENT AND ADJUSTABLE IN ASCENT. MADE FROM HM CARBON IT IS RIGID AND VERY STRONG.*

Cod.42070 ORTLES FULL HANDLE REPLACEMENT  
Cod.42060 ORTLES CORK HANDLE  
Cod.42061 ORTLES CLIP STRAP



ALU' LOCK

Material: Carbon Ø 14 + Carbon reinforcements  
Strap: Ortles Clip strap  
Handle: Ortles Cork handle  
Basket: Ortles basket  
Size: customised  
Weight: 235 gr.

Cod.42062  
TIPS+BASKET ORTLES QC



Cod.42042  
BASE AND NUT QC



Cod.42043  
BASKET GARA QC

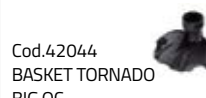

Cod.42044  
BASKET TORNADO  
BIG QC

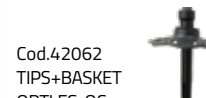

Cod.42062  
TIPS+BASKET  
ORTLES QC

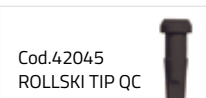

Cod.42045  
ROLLSKI TIP QC

## ORTLES ALU Cod.41142

ORTLES È IL BASTONE AD ALTA AFFIDABILITÀ FISSO IN DISCESA E REGOLABILE IN SALITA. VERSIONE IN ALLUMINIO.

*ORTLES IS A RELIABLE POLE FIXED IN DESCENT AND ADJUSTABLE IN ASCENT. ALLOY VERSION.*

Size: LENGTH: 110/115/120/125/130 cm FOR DOWNHILL EXTENDABLE TO 25 cm FOR ASCENT

Cod.42030 CLIP FOAM HANDLE  
Cod.42033 ALP CLIP STRAP

ALU' LOCK

Material: Alloy Ø 16 + Carbon reinforcements  
Strap: Alp Clip strap  
Handle: Foam handle  
Basket: Ortles basket  
Weight: 255 gr.

Cod.42062  
TIPS+BASKET ORTLES QC



Cod.42042  
BASE AND NUT QC



Cod.42043  
BASKET GARA QC

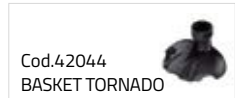

Cod.42044  
BASKET TORNADO  
BIG QC

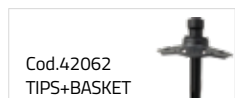

Cod.42062  
TIPS+BASKET  
ORTLES QC

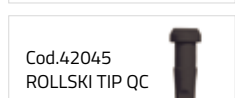

Cod.42045  
ROLLSKI TIP QC

# ONE PIECE TOURING POLES



## MAESTRO.2 Cod.41143

BASTONE IN ERGAL LEGGERO CON MANOPOLA FOAM E PAPERERA EVO.  
*POLES MADE OF LIGHT ERGAL WITH FOAM HANDLES AND EVO BASKETS.*

COD.42074 EVO STRAP  
COD.42073 MAESTRO.2 HANDLE

Material: Oval Ergal Ø 16x0.8  
Strap: Comfort strap  
Handle: Comfort grip handle foam  
Basket: Evo basket+Widia  
Size: 110cm-145cm each 5 cm  
Weight:210 gr 130cm

ERGAL Ø 16x0.8



EVO BASKET  
Cod. 42026



## EVO 3.0 Cod.41144

BASTONE IN ERGAL MOLTO ROBUSTO CON PUNTA WIDIA TONDA PER USO SCIALPINISTICO  
*VERY STRONG ERGAL POLES WITH ROUNDED WIDIA TIPS FOR USE IN SKI TOURING.*

COD.42074 EVO STRAP  
COD.42072 EVO 3.0 HANDLE

Material: Ergal Ø 18x0.8  
Strap: Comfort strap  
Handle: Comfort grip handle rubber  
Basket: Evo basket  
Size: 110cm-145 cm each 5 cm  
Weight: 230 gr 130cm

OVAL ERGAL TUBE Ø 18x0.8



EVO BASKET  
Cod. 42026



# TWO PIECES TOURING POLES



## MAGICO 16/14 CARBON

Cod.41149

BASTONE IN ERGAL E CARBONIO/KEVLAR 2 PEZZI CON PUNTA WIDIA TONDA PER USO SCIALPINISTICO.  
*2-PIECE ERGAL AND CARBON KEVLAR POLES WITH ROUNDED WIDIA TIPS FOR USE IN SKI TOURING.*

Cod.42030 FOAM- CLIP HANDLE  
 Cod.42033 ALP CLIP STRAP

Material: Ergal Ø 16x0.8 Carbon Ø 14 +kevlar reinforcements  
 Strap: Alp Clip strap  
 Handle: Foam clip handle  
 Basket: Evo basket  
 Size: adjustable 105cm-145 cm .  
 Weight:230 gr.

KEVLAR REINFORCEMENT



CAM LOCK LEVER



EVO BASKET  
 Cod. 42026



## GAVIA 18/16

Cod.41138

BASTONE 2 PEZZI IN ERGAL CON MANOPOLA FOAM E PUNTA WIDIA TONDA CON PAPERA USO SCIALPINISTICO.  
*2-PIECE ERGAL POLES WITH FOAM HANDLES, ROUNDED WIDIA TIPS AND SKI TOURING BASKETS.*

Cod.42030 FOAM- CLIP HANDLE  
 Cod.42033 ALP CLIP STRAP  
 FOAM GRIP SUPPORT

Material: Ergal Ø 18x0.8 +Ergal Ø 16x0.8  
 Strap: Alp Clip strap  
 Handle: Foam+SG clip handle  
 Basket: Evo basket  
 Size: Adjustable 105cm-145cm  
 Weight: 250 gr  
 Colore / Colour:  
 ○ WHITE  
 ● BLACK

EVO LOCK



EVO BASKET  
 Cod. 42026



# TWO PIECES TOURING POLES

## STELVIO Cod.41139

BASTONE IN ERGAL REGOLABILE A 2 PEZZI CON PUNTA WIDIA TONDA PER USO SCIALPINISTICO. DISPONIBILE IN DUE TAGLIE (95-125CM E 115-140CM)

ADJUSTABLE 2-PIECE ERGAL POLES WITH ROUNDED WIDIA TIPS FOR USE IN SKI TOURING. AVAILABLE IN TWO SIZES: 95-125CM AND 115-140CM

Cod.42046 FOAM- BORMIO HANDLE

Cod.42047 BORMIO STRAP



ALU' LOCK

Material: Ergal Ø 16 x 0.8 / 14 x 0.8  
Strap: Bormio strap  
Handle: Bormio Foam handle  
Basket: Bormio basket  
Size: adjustable 95cm-125 cm and 115-140cm  
Weight: 235 gr.



BORMIO basket  
cod. 42040



Trekking rubber



Summer basket





# THREE PIECES TOURING POLES

## SPRINT CARBON FOLDABLE Cod.41087

BASTONE componibile in 4 pezzi (36 cm) in carbonio molto leggero. Manopola leggera in schiuma e punta Widia tonda con papera doppio utilizzo (inverno/estate)  
*VERY LIGHT FOLDABLE 4-PIECE (36CM) CARBON POLES. LIGHT FOAM HANDLES AND ROUNDED WIDIA TIPS WITH DUAL-PURPOSE SKI/TREKKING BASKETS (WINTER/SUMMER).*

Cod.42049 SPRINT FOAM HANDLE  
 Cod.42048 SPRINT STRAP  
 FOAM GRIP SUPPORT

Material: foldable Carbon 4 pieces  
 Strap: Sprint strap  
 Handle: Sprint foam handle  
 Basket: Bormio basket  
 Size: adjustable 115cm-135cm (36cm closed)  
 Weight: 210 gr

FOLDABLE SYSTEM



ALU' LOCK

FOLDABLE CARBON 4 PIECES



BORMIO basket cod. 42040



Winter extension



Summer basket

## BORMIO 16/14/12 Cod.41090

BASTONE 3 pezzi in Ergal con manopola in schiuma e punta Widia tonda con papera doppio utilizzo (inverno/estate)

*3-PIECE ERGAL POLES WITH FOAM HANDLES, ROUNDED WIDIA TIPS AND DUAL-PURPOSE SKI/TREKKING BASKETS (WINTER/SUMMER).*

Cod.42046 FOAM- BORMIO HANDLE  
 Cod.42047 BORMIO STRAP  
 FOAM GRIP SUPPORT

Material: Ergal Ø 16x0.8 +Ergal Ø 14x0.8 +Ergal Ø 12x0.8  
 Strap: Bormio strap  
 Handle: Bormio foam handle  
 Basket: Bormio basket  
 Size: adjustable 105cm-135 cm (63.5cm closed)  
 Weight: 235 gr

ERGAL Ø 16x0.8  
 +ERGAL Ø 14x0.8  
 +ERGAL Ø 12x0.8



ALU' LOCK

BORMIO basket cod. 42040



Winter extension



Summer basket

GARA GLOVES



## GARA LITE COD. 27211

GUANTO DA GARA LEGGERO CON UN'OTTIMA TRASPIRABILITÀ; RINFORZI IN SILICONE SUL PALMO PER GARANTIRE UN BUON GRIP SUL BASTONE. ADATTO PER TEMPERATURE NON TROPPO RIGIDE. *LIGHTWEIGHT RACE GLOVE OFFERING EXCELLENT BREATHABILITY, WITH SILICONE SUPPORTS ON THE PALM TO GUARANTEE GRIP; SUITABLE FOR MILD TEMPERATURES.*

**Shell:** 3 Layer Polyester breathable soft shell, windproof

**Liner:** 100% Plan Polyester liner

**Palm:** Reinforced Microfiber palm + gripping silicone

**Insulation:** None

**Cuff:** Anatomic elastic Lycra

**Features:** Puller on cuff

**SIZE:** S - M - L - XL

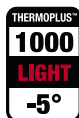

DRY TECHNOLOGY  
WATERPROOF AND  
WINDPROOF ON BACK  
WATCH WINDOWS





## GARA AERO COD. 27207

GUANTO DA GARA CON UNA BUONA VESTIBILITÀ GRAZIE ALLE DITA PREFORMATE E BUONA TERMICITÀ CON LA COVER A SCOMPARSA IN NYLON.

*RACE GLOVE OFFERING A SUPERIOR FIT THANKS TO ITS PREFORMED FINGERS AS WELL AS GOOD WARMTH DUE TO THE ROLL-AWAY NYLON COVER.*

**Shell:** 3 Layer Polyester breathable soft shell, windproof  
**Liner:** 100% Greed Fleece on palm + 100% Plan Polyester liner on back  
**Palm:** Goat leather on fingers + Microfiber reinforcement + Nylon fabric  
**Insulation:** Light and warm greed fleece technology  
**Cuff:** Breathable Neoprene  
**Features:** Outside stitching on fingers for better fit + windproof and water resistant cover on back pocket + cuff puller  
**SIZE:** XS - S - M - L - XL - XXL



## GARA AERO WMN COD. 27208

GUANTO DA GARA NELLA VERSIONE FEMMINILE PER ADATTARSI MEGLIO ALLE ESIGENZE DELLE ATLETE, CON OTTIMA VESTIBILITÀ GRAZIE ALLE DITA PREFORMATE. BUONA TERMICITÀ E COVER A SCOMPARSA IN NYLON.

*WOMEN'S RACE GLOVE DESIGNED ESPECIALLY FOR FEMALE ATHLETES WITH A SUPERIOR FIT THANKS TO THE PREFORMED FINGERS. GOOD WARMTH DUE TO THE ROLL-AWAY NYLON COVER.*

**Shell:** 3 Layer Polyester breathable soft shell, windproof  
**Liner:** 100% Greed Fleece on palm + 100% Plan Polyester liner on back  
**Palm:** Goat leather on fingers + Microfiber reinforcement + Nylon fabric  
**Insulation:** Light and warm greed fleece technology  
**Cuff:** Breathable Neoprene  
**Features:** Outside stitching on fingers for better fit + windproof and water resistant cover on back pocket + cuff puller  
**SIZE:** XS - S - M - L

<b>THERMOPLUS™</b> <b>1500</b> <b>LIGHT+</b> <b>-8°</b>	<b>THERMOPLUS™</b> <b>+500</b> <b>COVER</b> <b>Add-3°</b>	WATCH WINDOWS INSULATION FLEECE COVER DRY TECHNOLOGY WINDPROOF DURABLE WATER RESISTANCE	e-Touch System	GRAPHENE
--	--	---	----------------	----------

<b>THERMOPLUS™</b> <b>1500</b> <b>LIGHT+</b> <b>-8°</b>	<b>THERMOPLUS™</b> <b>+500</b> <b>COVER</b> <b>Add-3°</b>	WATCH WINDOWS INSULATION FLEECE COVER DRY TECHNOLOGY WINDPROOF DURABLE WATER RESISTANCE	e-Touch System	GRAPHENE
--	--	---	----------------	----------



## GARA PLUS COD. 27209

GUANTO DA GARA E ALLENAMENTO CON OTTIMA VESTIBILITÀ GRAZIE ALLE DITA PREFORMATE. BUONA TERMICITÀ. RACE AND TRAINING GLOVE WITH A SUPERIOR FIT THANKS TO THE PREFORMED FINGERS. GOOD WARMTH.

**Shell:** 3 Layer Polyester breathable soft shell, windproof  
**Liner:** 100% Greed Fleece on palm + 100% Plan Polyester liner on back  
**Palm:** Goat leather on fingers + Microfiber reinforcement + Nylon fabric  
**Insulation:** Light and warm greed fleece technology  
**Cuff:** Breathable Neoprene  
**Features:** Outside stitching on fingers for better fit + cuff puller  
**SIZE:** XS - S - M - L - XL - XXL

## GARA TEEN COD. 27210

GUANTO DA GARA E ALLENAMENTO JUNIOR CON OTTIMA VESTIBILITÀ GRAZIE ALLE DITA PREFORMATE. BUONA TERMICITÀ. RACE AND TRAINING JUNIOR GLOVE WITH A SUPERIOR FIT THANKS TO THE PREFORMED FINGERS. GOOD WARMTH.

**Shell:** 3 Layer Polyester breathable soft shell, windproof  
**Liner:** 100% Greed Fleece on palm + 100% Plan Polyester liner on back  
**Palm:** Microfiber with thumb and index finger reinforcement + conductive goat leather on index  
**Insulation:** Light and warm greed fleece technology  
**Cuff:** polyamide elastic fabric  
**Features:** Outside stitching on fingers for better fit + cuff puller  
**SIZE:** Jr.S - Jr.M - Jr.L





## OVERGLOVE GARA PLUS COD. 27212

COPRIGUANTO LEGGERO E COMPATTO MA ALLO STESSO TEMPO CON UN'OTTIMA TERMICITÀ, PERFETTO DA UTILIZZARE SOPRA IL GUANTO LEGGERO PER LA DISCESA.

*OVERGLOVE THAT IS LIGHTWEIGHT AND COMPACT, BUT ALSO VERY WARM, PERFECT FOR USE OVER A LIGHT GLOVE WHEN SKIING.*

**Shell:** 3 Layer Polyester breathable soft shell, windproof

**Liner:** 100% polyester smooth lining

**Palm:** 100% Nylon + Silicone printed lycra

**Insulation:** Polyester soft insulation 140 gr

**Cuff:** Double layer elastic lycra

**Features:** Opening palm system + cuff puller + elastic loop fixing system

**SIZE:** S - M - L



DRY TECHNOLOGY  
WINDPROOF  
DURABLE WATER RESISTANCE



INSULATION LEVEL LOFT 140g

WATCH WINDOWS



## GARA OVERGLOVE WATERPROOF COD. 27176

COPRIGUANTO COMPLETAMENTE IMPERMEABILE ED ANTIVENTO PER GARANTIRE LA MASSIMA PROTEZIONE ALL'ACQUA, MEMBRANA TRASPIRANTE E RINFORZI IN SILICONE SUL PALMO PER UN'OTTIMO GRIP.

*COMPLETELY WATERPROOF AND WINDPROOF OVERGLOVE TO GUARANTEE MAXIMUM PROTECTION FROM THE WET, BREATHABLE MEMBRANE AND SILICONE REINFORCEMENTS ON THE PALM FOR EXCELLENT GRIP.*

**Shell:** 100% Nylon stretch fabric + high breathable membrane

**Liner:** None

**Palm:** 100% Nylon stretch fabric + high breathable membrane + silicone print

Insulation: None

**Cuff:** 100% Nylon stretch fabric + high breathable membrane + silicone print

**Features:** Anatomic fit + puller on cuff

**SIZE:** S - M - L

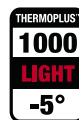

DRY TECHNOLOGY  
WINDPROOF  
HIGH DURABLE WATER RESISTANCE



HIGH BREATHABLE MEMBRANE

EXPERT GLOVES



## MAESTRO.2 COD. 27203

GUANTO MOLTO CONFORTEVOLE CON DITA PREFORMATE ED ERGONOMICHE E RINFORZI IN LYCRA PERFETTO SIA PER LA SALITA CHE PER LA DISCESA. RINFORZI ANATOMICI IN PELLE SUL PALMO E SUL POLLICE. IMBOTTITURA IN LANA SVIZZERA 100% CHE CONSENTE DI MIGLIORARE LA TRASPIRAZIONE PER CUI LA MANO RISULTA SEMPRE ASCIUTTA. POLSINO IN AIRPRENE. SISTEMA TOUCH CHE PERMETTE L'UTILIZZO DI SCHERMI TOUCH CON GUANTO INDOSSATO. POLSINO WINDOW WATCH.

*VERY COMFORTABLE GLOVE WITH PREFORMED ERGONOMIC FINGERS AND LYCRA REINFORCEMENTS. PERFECT FOR UPHILL AND DOWNHILL. ANATOMIC LEATHER REINFORCEMENTS ON THE PALM AND THUMB. 100% SWISS WOOL PADDING TO ENHANCE BREATHABILITY FOR HANDS THAT ARE ALWAYS DRY. AIRPRENE CUFF. TOUCH SYSTEM SO YOU CAN USE YOUR SMARTPHONE WITHOUT TAKING IT OFF. WATCH CHECK WINDOW.*

**Shell (back):** goat leather + neoprene + nylon stretch fabric

**Liner:** Fleece on palm + Polyester liner on the Back

**Palm:** goat leather

**Insulation:** wool insulation

**Cuff Palm:** polyamide elastic fabric

**Features:** Watch check window + cuff puller + original Swiss made wool

**SIZE:** XS - S - M - L - XL - XXL



DRY TECHNOLOGY  
WINDPROOF  
DURABLE WATER  
RESISTANCE  
GOAT LEATHER  
WATCH WINDOWS



e-Touch System



INSULATION



## ORTLES COD. 27196

GUANTO DA SCIALPINSIMO CON DITA ANATOMICHE E PREFORMATE E RIVESTIMENTO IN PELLE. RINFORZI IN PELLE SUL PALMO ED ATTORNO AL POLLICE CHE LO RENDONO OLTRE CHE CONFORTEVOLE ANCHE MOLTO RESISTENTE. FINESTRA SUL POLSINO PER POTER LEGGERE L'OROLOGIO.

*SKI TOURING GLOVE WITH ANATOMIC, PREFORMED FINGERS AND LEATHER COATING. LEATHER REINFORCEMENTS ON THE PALM AND AROUND THE THUMB MAKE IT BOTH COMFORTABLE AND VERY DURABLE. WATCH CHECK WINDOW ON THE CUFF.*

**Shell:** waterproof goat leather + stretch polyester fabric

**Liner:** 100% polyester Fleece

**Palm:** waterproof goat leather

**Insulation:** polyester 100 g

**Cuff:** breathable Neoprene

**Features:** window on back cuff for smartwatch + cuff puller

**SIZE:** XS - S - M - L - XL - XXL



 DRY TECHNOLOGY  
 WINDPROOF  
 WATERPROOF GOAT LEATHER  
 WATCH WINDOWS

 INSULATION  
 100 g Polyester



## MAGICO.2 COD. 27186

GUANTO DA SCIALPINSIMO CON DITA ANATOMICHE E PREFORMATE E RIVESTIMENTO IN PELLE. RINFORZI IN PELLE SUL PALMO ED ATTORNO AL POLLICE CHE LO RENDONO OLTRE CHE CONFORTEVOLE ANCHE MOLTO RESISTENTE. IMBOTTITURA 133GR PRIMALOFT GOLD PER UN'ALTA TERMICITÀ. FINESTRA SUL POLSINO PER POTER LEGGERE L'OROLOGIO. MEMBRANA INTERNA CHE CONSENTE UN'IMPERMEABILITÀ COMPLETA (7000/7000). CERTIFICATO THERMPLUS 3000.

*SKI TOURING GLOVE WITH ANATOMIC, PREFORMED FINGERS AND LEATHER COATING. LEATHER REINFORCEMENTS ON THE PALM AND AROUND THE THUMB MAKE IT BOTH COMFORTABLE AND VERY DURABLE. EXTREMELY WARM THANKS TO A 133G PRIMALOFT GOLD PADDING. WATCH CHECK WINDOW ON THE CUFF. AN INTERNAL MEMBRANE PROVIDES A COMPLETE WATERPROOFING BARRIER (7000/7000) AND ENSURES WARMTH STANDARD OF THERMOPLUS 3000.*

**Shell:** Leather Goat

**Liner:** 100% Plan Polyester Liner

**Palm:** Leather Goat

**Insulation:** 133 gr Primaloft Gold

**Cuff:** Leather Goat



**Features:** Leather reinforcements on thumb and palm + cuff puller + weaved elastic fabric + watch check window + breathable insert, 5 fingers, Thermoplus 3000 certified

**Waterproof:** 7000/7000

**SIZE:** XS - S - M - L - XL - XXL



 DRY TECHNOLOGY  
 WINDPROOF  
 WATERPROOF  
 GOAT LEATHER

 WATCH WINDOWS  
 INSULATION  
 133 g primaloft gold





## GAVIA WRISTGLOVE COD. 27205

COPRIGUANTO IMBOTTITO RIPIEGABILE IN UN COMODO POLSINO. OTTIMA TERMICITÀ CON COPERTURA TOTALE DELLA MANO. DA TENERE SEMPRE CON SE IN CASO DI EMERGENZA.  
*PADDED OVERGLOVE THAT CAN BE FOLDED INTO A PRACTICAL POCKET IN THE CUFF.  
COVERS THE ENTIRE HAND, OFFERING OPTIMAL WARMTH.  
KEEP WITH YOU WHEN SKIING IN CASE OF EMERGENCY.*

**Shell:** nylon 100%  
**Palm:** nylon fabric with silicone print  
**Insulation:** levelloft 140 gr  
**Cuff:** polyester fabric with elastic borders  
**Features:** pocket with zip for overglove  
**SIZE:** S - M - L



INSULATION LEVEL LOFT 140 g



innovation  
PRODUCT



## STELVIO COD. 27204

GUANTO DA SCIALPINSIMO IN POLARTECH CON COVER IMBOTTITA. RINFORZI IN PELLE SUL PALMO. IMBOTTITURA 140 GR LEVELLOFT PER UN'ALTA TERMICITÀ. SISTEMA TOUCH CHE PERMETTE L'UTILIZZO DI SCHERMI TOUCH CON GUANTO INDOSSATO.  
*POLARTECH SKI TOURING GLOVE WITH PADDED COVER. LEATHER-REINFORCED PALMS. 140 GR LEVELLOFT PADDING FOR SUPERIOR WARMTH. TOUCH SYSTEM LETS YOU USE TOUCH SCREENS WITHOUT HAVING TO REMOVE YOUR GLOVE.*

**Shell (Back):** Polartec + 3 Layer Polyester Breathable Soft Shell, Windproof + Nylon Cover.  
**Palm:** Polartec Fabric + Goat Leather Patch + Conductive Micropile On Index Finger.  
**Insulation:** Soft Polyester Insulation 140 G Inside The Cover  
**Cuff Palm:** Polyamide Stretch Fabric  
**Features:** pocket for overglove, Trilaminat fabric for sweat or nose cleaning  
**SIZE:** XS - S - M - L - XL - XXL

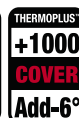

DRY TECHNOLOGY  
WINDPROOF  
DURABLE WATER  
RESISTANCE  
INSULATION  
LEVEL LOFT 140 g





## COMFORT GLOVES



### K LIGHT MITT COD. 27199 - RED/BLACK

MOFFOLA CON UNA BUONA TERMICITÀ, MOLTO MORBIDA E PERFETTA DA UTILIZZARE PER LA DISCESA, OCCUPA POCHISSIMO SPAZIO ED OFFRE UN OTTIMO COMFORT.

*VERY SOFT, WARM MITTEN, PERFECT FOR SKIING, TAKING UP LITTLE SPACE AND OFFERING SUPERB COMFORT.*

**Shell:** 100% polyamide fabric

**Liner:** 100% Plan Polyester liner

**Palm:** polyester fabric with microfiber reinforcement

**Insulation:** Polyester Soft insulation 140 gr

**Cuff:** 100% polyamide fabric

**Features:** microfiber reinforcements on palm and thumb + cuff puller

**SIZE:** XS - S - M - L - XL - XXL



- COLOURS  
RED / BLACK
- ☾ INSULATION  
140 g POLYESTER LOFT



### OVERGLOVE K LIGHT COD. 27206

COPRIGUANTO CON UNA BUONA TERMICITÀ, MOLTO MORBIDA E PERFETTA DA UTILIZZARE PER LA DISCESA, OCCUPA POCHISSIMO SPAZIO ED OFFRE UN OTTIMO COMFORT.

*VERY SOFT, WARM OVERGLOVE, PERFECT FOR SKIING, TAKING UP LITTLE SPACE AND OFFERING SUPERB COMFORT.*

**Shell (Back):** Nylon Fabric

**Liner:** Polyester Liner

**Palm:** Taslan Fabric + Suede

**Insulation:** Soft Polyester Insulation 140 Gr

**Cuff Palm:** Lycra Fabric

**Features:** Opening On Palm To Let The Hand Out + Cuff Puller

**SIZE:** S - M - L



- ☾ INSULATION  
140 g POLYESTER LOFT



## NORDIC 2

COD. 27198 - 27198BLU - 27198RED

GUANTO CON 5 DITA CON UNA BUONA TERMICITÀ E OTTIMA MOBILITÀ DELLA MANO GRAZIE ALLA BUONA VESTIBILITÀ E AI MATERIALI MOLTO MORBIDI, MOLTO CONFORTEVOLE ED ADATTO SIA PER LO SCIALPINSIMO CHE PER TUTTE LE ALTRE ATTIVITÀ INVERNALI QUALI SCI NORDICO, SALITA CON LE CIASPOLE E NORDIC WALKING.

*5-FINGER GLOVE, VERY WARM, EXCELLENT DEXTERITY THANKS TO SUPERIOR FIT AND SOFT FABRICS; VERY COMFORTABLE AND SUITABLE FOR SKI TOURING AS WELL AS OTHER WINTER ACTIVITIES LIKE CROSS-COUNTRY SKIING, SNOW SHOEING AND NORDIC WALKING.*

**Shell:** layer polyester breathable soft shell with silicone print, windproof

**Liner:** 100% Plan Polyester Liner

**Palm:** Microfiber with thumb and index finger reinforcement

**Insulation:** 100% polyester liner

**Cuff:** polyamide elastic fabric

**Features:** Outside stitching on fingers for better fit + suede reinforcement patch

**SIZE:** XS - S - M - L - XL - XXL



DRY TECHNOLOGY  
WINDPROOF  
DURABLE WATER RESISTANCE

COLOURS  
BLACK / RED / BLUE

INSULATION Polyester liner



## K EVO WOOL

COD. 27214 Ottanio - COD. 27200 Black

GUANTO A 5 DITA MOLTO CALDO E CONFORTEVOLE. MASSIMO DELLA RICERCA QUANTO A FUNZIONALITÀ, TERMICITÀ E USO DI MATERIALI INNOVATIVI. UTILIZZA UNA NUOVA SOLUZIONE DI ISOLAMENTO CHE ABBINA UNO STRATO DI LANA E LOFT SOFT CHE CONSENTE DI AVERE SEMPRE LE MANI CALDE ED ASCIUTTE. POLSINO CON SISTEMA WINDOW WATCH

*VERY WARM AND COMFORTABLE 5-FINGER GLOVES. CUTTING-EDGE RESEARCH AS WELL AS FUNCTIONALITY, WARMTH AND INNOVATIVE MATERIALS. USES A NEW KIND OF INSULATION WHICH COMBINES A LAYER OF WOOL AND LOFT SOFT FOR HANDS THAT ARE ALWAYS WARM AND DRY. WINDOW FOR SMART WATCH.*

**Shell:** Breathable and WP laminated Polyamide

**Liner:** 100% Plan Polyester liner

**Palm:** goat leather palm + goat leather patch reinforcement

**Insulation:** 100% Wool insulation on the back + soft insulation on the palm

**Cuff:** 100% Polyester

**Features:** elastic cuff for easy fit in & out

**SIZE:** XS - S - M - L - XL - XXL



Wool Shell

Soft Insulation Fabrics  
Inner Fabrics



DRY TECHNOLOGY  
WINDPROOF  
DURABLE WATER RESISTANCE

COLOURS  
BLACK / OTTANIO

WATCH WINDOWS  
INSULATION LEVEL LOFT 140 g



INSULATION



## MITT CABRIO K EVO WOOL

COD. 27215 Ottanio - COD. 27201 Black

GUANTO CON UN INNOVATIVO SISTEMA DI ISOLAZIONE CHE GARANTISCE OTTIMA TERMICITÀ E MANI SEMPRE ASCIUTTE. AL LOFT SOFT CHE LO RENDE UN GUANTO MOLTO CALDO E MORBIDO VIENE AGGIUNTO UNO STRATO DI LANA CHE TRATTIENE L'UMIDITÀ E TIENE LA MANO PIÙ ASCIUTTA. SISTEMA CABRIO CHE CONSENTE DI LIBERARE LE DITA, INCLUSO IL POLLICE, PER AVERE MAGGIORE MANUALITÀ. POLSINO CON WINDOW WATCH.

*GLOVE WITH AN INNOVATIVE INSULATION SYSTEM THAT GUARANTEES WARM, DRY HANDS. LOFT SOFT PADDING MAKES THE GLOVE WARM AND SOFT WITH AN ADDITIONAL LAYER OF WOOL TO SOAK UP MOISTURE AND KEEP THE HAND DRY. THE CABRIO SYSTEM LETS YOU FREE FINGERS AND THUMB TO INCREASE DEXTERITY. WINDOW FOR SMART WATCH.*

**Shell:** Breathable and WP laminated Polyamide

**Liner:** 100% Plan Polyester liner

**Palm:** Goat leather palm + goat leather patch reinforcement

**Insulation:** 100% Wool insulation on the back + soft insulation on the palm

**Cuff:** 100% Polyester

**Features:** elastic cuff offers easy on/off flexibility

**SIZE:** XS - S - M - L - XL - XXL

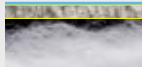

Wool Shell

Soft Insulation Fabrics  
Inner Fabrics



## K SPORT COD. 27195

GUANTO MOLTO LEGGERO CON COVER IN LYCRA ANTIVENTO E RINFORZI AL SILICONE SUL PALMO PER AUMENTARE IL GRIP SUL BASTONE - TECNOLOGIA TOUCH PER POTER UTILIZZARE SMARTPHONE CON GUANTO INDOSSATO.

*VERY LIGHTWEIGHT GLOVE WITH WINDPROOF LYCRA COVER AND SILICONE REINFORCEMENTS ON THE PALM FOR EXCELLENT GRIP - TOUCH TECHNOLOGY TO USE SMARTPHONE WITHOUT TAKING IT OFF.*

**Shell:** Polyester stretch knitted

**Liner:** Polyester stretch knitted

**Palm:** microfiber with silicon print for a better grip

**Cuff:** Cover in nylon high density silver coating

**Features:** windproof and waterproof cover + reflex piping

**SIZE:** XS - S - M - L - XL - XXL

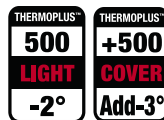

DRY TECHNOLOGY  
WINDPROOF



DRY TECHNOLOGY  
WINDPROOF  
DURABLE WATER RESISTANCE

WATCH WINDOWS

INSULATION LEVEL LOFT 140g



COLOURS  
BLACK / OTTANIO



INSULATION

# HELMETS



- |   |  |   |
|---|--|---|
| <b>MOUNTAINEERING</b>   | <b>DOWNHILL</b>  | <b>BIKE</b>   |
|  |  |  |
| CE EN 12492   | CE EN 1077-B   | CE EN 1078  |

## AERO HELMET

CASCO MOLTO LEGGERO CON UN'OTTIMA CALZATA. OMOLOGATO SIA PER L'ALPINISMO (CE EN 12492) CHE PER LO SCI ALPINO (CE EN 1077-B) COSÌ DA RISPONDERE ALLA NORMATIVA ISFM, HA UN REGOLATORE DI CIRCONFERENZA TESTA DI VELOCE E FACILE UTILIZZO ATOP LACING SYSTEM. CASCO PER GLI SCIATORI CHE VOGLIONO SICUREZZA A 360°. LIGHTWEIGHT HELMET WITH AN EXCELLENT FIT. EC APPROVED FOR SKI MOUNTAINEERING (EC EN 12492), ALPINE SKIING (EC EN 1077-B), IN ACCORDANCE WITH ISFM REGULATIONS, WITH AN ADJUSTMENT WHEEL ATOP LACING SYSTEM TO FIT THE HEAD THAT IS QUICK AND EASY TO USE. A HELMET FOR SKIERS WHO WANT 360° OF SAFETY.

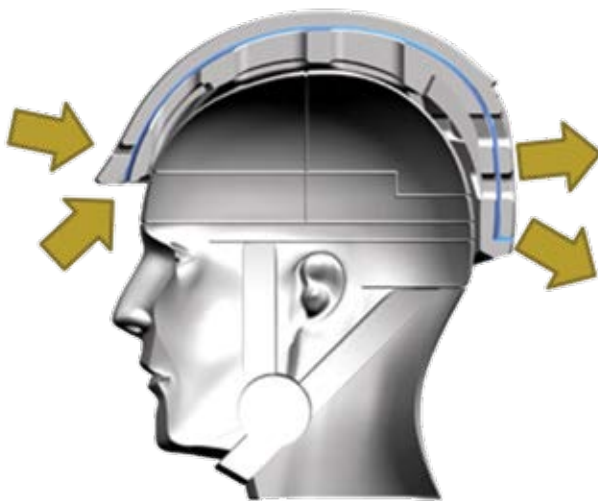

### HOLLOW CORE TECHNOLOGY

2 EPS (in-mould construction) are assembled to create 6 air canals to ventilate the shell



## AERO COD. 36023

### Material:

Shell: Polycarbonate shell with matte finishing

Interior: High density polystyrene

Sizes: M (53-57) and L (58-62)

Colours: Dark Grey

Weight: 290 gr (52-58)

Microfiber foam padding - Size adjustment wheel easy to use

Elastic straps for ski goggles and lamp

Approval:

Mountaineering (EC EN 12492)

Alpine skiing (EC EN 1077-B)

Cycling (EC EN 1078)



## AERO COD. 36023 WHI



## EVO PADDING AERO HELMET COD. 36037



## AERO COD. 36023 BLA



Elastic Strap for goggles - COD. 36031



## ATTIVO COD. 36030 WHI

CASCO PARTICOLARMENTE LEGGERO E CONFORTEVOLE, OMOLOGATO PER L'ALPINISMO (CE EN 12492), HA UN REGOLATORE DI CIRCONFERENZA TESTA DI VELOCE E FACILE UTILIZZO. È ADATTO AGLI SCIALPINISTI CHE VOGLIONO SCIARE IN SICUREZZA, SENZA RINUNCIARE A CONFORT E PRATICITÀ. E' POSSIBILE APPLICARE LA MASCHERA MAXIMO CON COMODO SISTEMA DI FISSAGGIO CHE LA RENDE PARTICOLARMENTE FUNZIONALE.

*A VERY LIGHT, COMFORTABLE HELMET, EC APPROVED (EC EN 12492) FOR SKI MOUNTAINEERING, WITH ADJUSTMENT WHEEL TO FIT THE HEAD THAT IS QUICK AND EASY TO USE. IT IS SUITABLE FOR SKI TOURERS WHO WANT TO SKI IN SAFETY, WITHOUT COMPROMISING ON COMFORT AND PRACTICALITY. YOU CAN ATTACH MAXIMO GOGGLES WITH A CONVENIENT MOUNTING SYSTEM THAT MAKES IT INCREDIBLY FUNCTIONAL.*

### Material:

Shell: external polycarbonate shell  
Interior: high density polystyrene  
Size: M (52-58) and L (59-62)  
Colours: Black and White  
Weight: 210 gr  
Omologazione / Approval:  
Mountaineering (EC EN 12492)

MOUNTAINEERING



## ATTIVO COD. 36030 BLACK

CASCO PARTICOLARMENTE LEGGERO E CONFORTEVOLE, OMOLOGATO PER L'ALPINISMO (CE EN 12492), HA UN REGOLATORE DI CIRCONFERENZA TESTA DI VELOCE E FACILE UTILIZZO. È ADATTO AGLI SCIALPINISTI CHE VOGLIONO SCIARE IN SICUREZZA, SENZA RINUNCIARE A CONFORT E PRATICITÀ. E' POSSIBILE APPLICARE LA MASCHERA MAXIMO CON COMODO SISTEMA DI FISSAGGIO CHE LA RENDE PARTICOLARMENTE FUNZIONALE.

*A VERY LIGHT, COMFORTABLE HELMET, EC APPROVED (EC EN 12492) FOR SKI MOUNTAINEERING, WITH ADJUSTMENT WHEEL TO FIT THE HEAD THAT IS QUICK AND EASY TO USE. IT IS SUITABLE FOR SKI TOURERS WHO WANT TO SKI IN SAFETY, WITHOUT COMPROMISING ON COMFORT AND PRACTICALITY. YOU CAN ATTACH MAXIMO GOGGLES WITH A CONVENIENT MOUNTING SYSTEM THAT MAKES IT INCREDIBLY FUNCTIONAL.*

### Material:

Shell: external polycarbonate shell  
Interior: high density polystyrene  
Size: M (52-58) and L (59-62)  
Colours: Black and White  
Weight: 210 gr  
Omologazione / Approval:  
Mountaineering (EC EN 12492)

MOUNTAINEERING





## ATTIVO COD. 36030 BLACK/PIN

CASCO PARTICOLARMENTE LEGGERO E CONFORTEVOLE, OMOLOGATO PER L'ALPINISMO (CE EN 12492), HA UN REGOLATORE DI CIRCONFERENZA TESTA DI VELOCE E FACILE UTILIZZO. È ADATTO AGLI SCIALPINISTI CHE VOGLIONO SCIARE IN SICUREZZA, SENZA RINUNCIARE A CONFORT E PRATICITÀ. E' POSSIBILE APPLICARE LA MASCHERA MAXIMO CON COMODO SISTEMA DI FISSAGGIO CHE LA RENDE PARTICOLARMENTE FUNZIONALE.

*A VERY LIGHT, COMFORTABLE HELMET, EC APPROVED (EC EN 12492) FOR SKI MOUNTAINEERING, WITH ADJUSTMENT WHEEL TO FIT THE HEAD THAT IS QUICK AND EASY TO USE. IT IS SUITABLE FOR SKI TOURERS WHO WANT TO SKI IN SAFETY, WITHOUT COMPROMISING ON COMFORT AND PRACTICALITY. YOU CAN ATTACH MAXIMO GOGGLES WITH A CONVENIENT MOUNTING SYSTEM THAT MAKES IT INCREDIBLY FUNCTIONAL.*

### Material:

Shell: external polycarbonate shell  
 Interior: high density polystyrene  
 Size: M (52-58) and L (59-62)  
 Colours: Black and White  
 Weight: 210 gr  
 Omologazione / Approval:  
 Mountaineering (EC EN 12492)

MOUNTAINEERING



## ATTIVO COD. 36030 BLACK/ORA

CASCO PARTICOLARMENTE LEGGERO E CONFORTEVOLE, OMOLOGATO PER L'ALPINISMO (CE EN 12492), HA UN REGOLATORE DI CIRCONFERENZA TESTA DI VELOCE E FACILE UTILIZZO. È ADATTO AGLI SCIALPINISTI CHE VOGLIONO SCIARE IN SICUREZZA, SENZA RINUNCIARE A CONFORT E PRATICITÀ. E' POSSIBILE APPLICARE LA MASCHERA MAXIMO CON COMODO SISTEMA DI FISSAGGIO CHE LA RENDE PARTICOLARMENTE FUNZIONALE.

*A VERY LIGHT, COMFORTABLE HELMET, EC APPROVED (EC EN 12492) FOR SKI MOUNTAINEERING, WITH ADJUSTMENT WHEEL TO FIT THE HEAD THAT IS QUICK AND EASY TO USE. IT IS SUITABLE FOR SKI TOURERS WHO WANT TO SKI IN SAFETY, WITHOUT COMPROMISING ON COMFORT AND PRACTICALITY. YOU CAN ATTACH MAXIMO GOGGLES WITH A CONVENIENT MOUNTING SYSTEM THAT MAKES IT INCREDIBLY FUNCTIONAL.*

### Material:

Shell: external polycarbonate shell  
 Interior: high density polystyrene  
 Size: M (52-58) and L (59-62)  
 Colours: Black and White  
 Weight: 210 gr  
 Omologazione / Approval:  
 Mountaineering (EC EN 12492)

MOUNTAINEERING



# AERO GOGGLES



## GLASS AERO TRANSPARENT 0/2

COD. 36036

MODEL	TRANSPARENT
VENTILATION	FRONTAL & LATERAL
ANTIFOG	ANTIFOG
CLASS	DOUBLE LENS
CATEGORY	0-2
TYPE OF LENS	PHOTOCROMIC
COLOUR	NONE
DETAILS	NOSE SUPPORT - 3CM ELASTIC ADJUSTABLE VELCRO
WEIGHT	57 g

ESPECIFICALLY DESIGNED FOR SKIMO

SIDE VENTILATION

FRONT VENTILATION (5 POINTS)

ADJUSTABLE ELASTIC BAND 3 CM

4-LAYER FOAM

SHAPE WITH VENTILATION CHANNELS

SPHERICAL LENS WITH HARDENING TREATMENT ON THE OUTER SURFACE

WORLDWIDE PATENTED FOG STOP TECHNOLOGY

WIDE ANGLE

ANTI-SCRATCH LENS

100% UV PROTECTION

MADE IN ITALY

FRONT VENTILATION



NOSE SUPPORT



ADJUSTABLE ELASTIC 3cm



UPPER FOAM







## GLASS AERO ORANGE 2

COD. 36038

MODEL	ORANGE
VENTILATION	FRONTAL & LATERAL
ANTIFOG	ANTIFOG
CLASS	DOUBLE LENS
CATEGORY	2
TYPE OF LENS	REGULAR
COLOUR	ORANGE
DETAILS	NOSE SUPPORT - 3CM ELASTIC ADJUSTABLE VELCRO
WEIGHT	57 g

FRONT VENTILATION



NOSE SUPPORT



ADJUSTABLE ELASTIC 3cm



UPPER FOAM



## GLASS AERO SMOKY 4

COD. 36035

MODEL	SILVER MIRROR
VENTILATION	FRONTAL & LATERAL
ANTIFOG	ANTIFOG
CLASS	DOUBLE LENS
CATEGORY	4
TYPE OF LENS	MIRROR
COLOUR	SILVER
DETAILS	NOSE SUPPORT - 3CM ELASTIC ADJUSTABLE VELCRO
WEIGHT	57 g

FRONT VENTILATION



NOSE SUPPORT



ADJUSTABLE ELASTIC 3cm



UPPER FOAM



# TOURING GOGGLES



ESPECIFICALLY DESIGNED FOR SKIMO

VERTICAL VENTILATION

ADJUSTABLE ELASTIC BAND 4 CM

4-LAYER FOAM

SHAPE WITH VENTILATION CHANNELS

SPHERICAL LENS WITH HARDENING TREATMENT ON THE OUTER SURFACE

WORLDWIDE PATENTED FOG STOP TECHNOLOGY

WIDE ANGLE

ANTI-SCRATCH LENS

100% UV PROTECTION

MADE IN ITALY



## GLASS NEVE 2

COD. 36033

MODEL	UNILENS
VENTILATION	VERTICAL
ANTIFOG	ANTIFOG
CLASS	DOUBLE LENS
CATEGORY	2
TYPE OF LENS	MIRROR
COLOUR	BLUE
DETAILS	4 CM ELASTIC ADJUSTABLE
WEIGHT	62 g

VERTICAL VENTILATION



NOSE SUPPORT



ADJUSTABLE ELASTIC 4 cm



UPPER FOAM





## GLASS NEVE PHOTOCROMATIC 1/3

COD. 36032

MODEL	BIG SINGLE LENS
VENTILATION	VERTICAL
ANTIFOG	ANTIFOG
CLASS	SINGLE LENS
CATEGORY	1-3
TYPE OF LENS	MIRROR AND PHOTOCROMIC
COLOUR	GOLD
DETAILS	4 CM ELASTIC ADJUSTABLE
WEIGHT	62 g



## GLASS NEVE 4

COD. 36034

MODEL	MIRROR LENS
VENTILATION	VERTICAL
ANTIFOG	ANTIFOG
CLASS	DOUBLE LENS
CATEGORY	4
TYPE OF LENS	MIRROR
COLOUR	YELLOW/RED
DETAILS	4 CM ELASTIC ADJUSTABLE
WEIGHT	62 g

VERTICAL VENTILATION



NOSE SUPPORT



ADJUSTABLE ELASTIC 4 cm



UPPER FOAM



VERTICAL VENTILATION



NOSE SUPPORT



ADJUSTABLE ELASTIC 4 cm



UPPER FOAM



# BACKPACKS



BACKPACKS DEVELOPED FOR YOUR VERTICAL ADVENTURES.

COMFORT AND FUNCTIONALITY WITH AN EYE FOR SAFETY.

DESIGNED AND MADE BY TRUE SKI TOURING PROFESSIONALS.

*ZAINI SVILUPPATI PER LE TUE AVVENTURE VERTICALI SUGLI SCI.*

*COMFORT E FUNZIONALITÀ CON UN OCCHIO RIVOLTO ALLA SICUREZZA.*

*PROGETTATI E REALIZZATI DAI PROFESSIONISTI DELLO SCI ALPINISMO, QUELLO VERO.*



**INSULATED WATER  
BLADDER 2L**  
COD. 23088



**WATER  
BLADDER 2L**  
COD. 23089



**BOTTLE 350 ML**  
COD. 23091



**INSULATED  
BOTTLE 500 ML**  
COD. 23090

# GARA 2.0 cod. 23083

CALZATA ERGONOMICA, VOLUME RIDOTTO, PER UNO ZAINO IN CUI RIPORRE LO STRETTO NECESSARIO.  
TASCA PORTACASCO E TASCHE ESTERNE PER ACCESSORI,  
ZAINO IDEALE PER LO SKI FITNESS, BIKE E RUNNING.

CAPACITÀ/CAPACITY: 22 LT  
TESSUTO/FABRICS: NYLON, POLYESTER, LYCRA, EVA  
PESO/WEIGHT: 390 GR

*ERGONOMIC FIT AND REDUCED VOLUME FOR A BACKPACK WHERE YOU CAN STORE THE BARE ESSENTIALS, IDEAL FOR FITNESS SKI TOURING, RUNNING AND CYCLING.*



1 - 2ND SKI HOLDER



2 - CRAMPON POCKET



3 - ADJUSTABLE SKI HOLDER



4 - ICE AXE LOOP



5 - KEY POCKET



6 - WATER BLADDER POCKET



7 - ELASTIC FIXING SYSTEM AT CHEST LEVEL



8 - SHOVEL AND PROBE POCKET



9 - SHOULDER POCKET WITH ZIP



10 - PADDED BACK



11 - FLASK POCKET



# SPRINT 2 cod. 23086

CALZATA ERGONOMICA, VOLUME RIDOTTO, PER UNO ZAINO IN CUI RIPORRE LO STRETTO NECESSARIO. TASCA PORTACASCO E TASCHE ESTERNE PER ACCESSORI. ZAINO IDEALE PER LO SKI FITNESS, BIKE E RUNNING.

ERGONOMIC FIT AND REDUCED VOLUME FOR A BACKPACK WHERE YOU CAN STORE THE BARE ESSENTIALS. IDEAL FOR RUNNING, CYCLING AND FITNESS SKI TOURING.

CAPACITÀ / CAPACITY: 15 LT  
TESSUTO / FABRICS: EVA, NYLON, POLYESTER  
PESO / WEIGHT: 440 GR



1 - BOTTLE HOLDER



2 - HELMET NET HOUSING



3 - LATERAL POCKET WITH ZIP



4 - BREATHABLE SHOULDER STRAPS



5 - SKI LOOP



6 - SHAPED WAIST BELT WITH TWO POCKETS



7 - ASYMMETRICAL WAIST ADJUSTMENT



8 - PADDED BACK



9 - MAGNETIC CHEST SYSTEM



10 - HIKING POLE HOLDER



11 - WATERPROOF ZIP



12 - COMPATIBLE WITH WATER BLADDER



# MAGICO 2 COD. 23087

MAGICO 2 È IL NUOVO ZAINO SVILUPPATO PER LE TUE AVVENTURE VERTICALI. COMFORT E FUNZIONALITÀ CON UN OCCHIO ALLA SICUREZZA E FUNZIONALITÀ INNOVATIVE. PROGETTATO E REALIZZATO DAI PROFESSIONISTI DELLO SCI ALPINISMO, QUELLO VERO.  
 MAGICO 2 IS THE NEW BACKPACK DEVELOPED FOR YOUR VERTICAL ADVENTURES. COMFORT AND FUNCTIONALITY WITH AN EYE FOR SAFETY AND EXTRAORDINARY FEATURES.  
 DESIGNED AND MADE BY TRUE SKI TOURING PROFESSIONALS.

CAPACITÀ/CAPACITY: 22LT  
 TESSUTO/FABRICS: EVA - NYLON - POLYESTER  
 PESO/WEIGHT: 700 GR



1 - QUICK ACCESS PROBE POCKET



2 - CRAMPONS POCKET



3 - BOTTLE HOLDER



4 - EVA BACK PANEL



5 - SNOW AXE SUPPORT



6 - SKI LOOP AND AXE LOOP



7 - POCKET WITH KEY HOOK



8 - ASYMMETRICAL WAIST ADJUSTMENT



9 - WATERPROOF ZIP



10 - HELMET NET HOUSING



11 - WATER REPELLENT FRONT PANEL



12 - MAGNETIC CHEST SYSTEM



# ORTLES 26 COD. 23084

ORTLES È LO ZAINO SVILUPPATO PER LE LO SCIALPINISMO. COMFORT, FUNZIONALITÀ, REPARTO SICUREZZA E FUNZIONALITÀ INNOVATIVE. PROGETTATO E REALIZZATO DAI PROFESSIONISTI DELLO SCI ALPINISMO, QUELLO VERO. VERSIONE DA 26 LT. *MAGICO 2 IS THE NEW BACKPACK DEVELOPED FOR SKI TOURING ADVENTURES. COMFORT, FUNCTIONALITY, SPACE FOR SAFETY AND EXTRAORDINARY FEATURES. DESIGNED AND MADE BY TRUE SKI TOURING PROFESSIONALS. 26 LT VERSION.*

CAPACITÀ/CAPACITY: 26LT  
TESSUTO/FABRICS: EVA - NYLON - POLYESTER  
PESO/WEIGHT: 880 GR



1 - SAFETY POCKET WITH RED PULLER



2 - EVA BACK PANEL



3 - DOUBLE ACCESS TO MAIN POCKET



4 - HELMET NET HOUSING



5 - ADJUSTABLE SKI HOLDER



6 - SECONDARY POCKET WITH KEY HOOK



7 - RAINCOVER



8 - DOUBLE LOOP FOR CARABINER



9 - SKI LOOP AND AXE LOOP



10 - BOTTLE POCKET ON BOTH SHOULDERS



11 - SIDE SKI HOLDER



12 - WATERPROOF ZIP

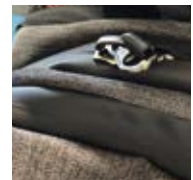



# ORTLES 30 COD. 23085

ORTLES È LO ZAINO SVILUPPATO PER LE LO SCIALPINISMO. COMFORT, FUNZIONALITÀ, REPARTO SICUREZZA E FUNZIONALITÀ INNOVATIVE. PROGETTATO E REALIZZATO DAI PROFESSIONISTI DELLO SCI ALPINISMO, QUELLO VERO. VERSIONE DA 30 LT. *MAGICO 2 IS THE NEW BACKPACK DEVELOPED FOR SKI TOURING. ADVENTURES. COMFORT, FUNCTIONALITY, SPACE FOR SAFETY AND EXTRAORDINARY FEATURES. DESIGNED AND MADE BY TRUE SKI TOURING PROFESSIONALS. 30 LT VERSION.*

CAPACITÀ/CAPACITY: 30LT  
TESSUTO/FABRICS: EVA - NYLON - POLYESTER  
PESO/WEIGHT: 950 GR



1 - SAFETY POCKET WITH RED PULLER



2 - EVA BACK PANEL



3 - DOUBLE ACCESS TO MAIN POCKET



4 - HELMET NET HOUSING



5 - ADJUSTABLE SKI HOLDER



6 - SECONDARY POCKET WITH KEY HOOK



7 - RAINCOVER



8 - DOUBLE LOOP FOR CARABINER



9 - SKI LOOP AND AXE LOOP



10 - BOTTLE POCKET ON BOTH SHOULDER



11 - SIDE SKI HOLDER



12 - WATERPROOF ZIP

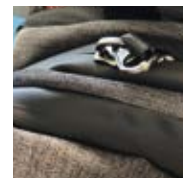

# STELVIO TRAVEL BAG/ BACKPACK 40 LT - COD. 52091

CAPACITÀ / CAPACITY: 40LT  
TESSUTO / FABRICS: EVA - NYLON  
TARAPULIN  
PESO / WEIGHT: 1080 GR

BORSA / ZAINO CON SPALLACCI TRASFORMABILI IN MANIGLIE PER IL TRASPORTO. SUPPORTO POSTERIORE 3D STAMPATO IN EVA E NYLON, CON APERTURA A TUTTA LUNGHEZZA. 12 TASCHE OLTRE ALLO SCOMPARTO PRINCIPALE. TASCA ESTERNA PER DOCUMENTI, VANO PER LE SCARPE. FERMO ELASTICO.

BAG/BACKPACK WITH SHOULDER STRAPS CONVERTIBLE INTO CARRYING HANDLES. PRINTED BACK SUPPORT MADE OF EVA AND NYLON, WITH FULL-LENGTH OPENING. 12 POCKETS IN ADDITION TO THE MAIN COMPARTMENT. EXTERNAL POCKET FOR DOCUMENTS, SHOE COMPARTMENT. ELASTICATED RETAINER.

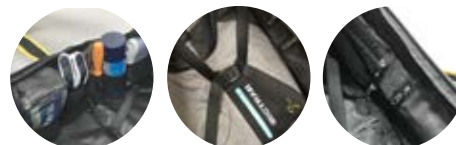

POCKETS AND INNER ACCESSORIES

EXTERNAL POCKET

SBS ZIP



ADJUSTABLE SHOULDERS (3 POSITIONS) CONVERTIBLE INTO CARRYING HANDLES



EXTERNAL POCKET FOR DOCUMENTS DOCUMENTI



EVA MOULDED BACK PANEL



SOFT SHOULDERS MADE OF NEOPRENE + ELASTIC



## GARA DUFFLE COD. 52092

BORSA / ZAINO CON SPALLACCI TRASFORMABILI IN MANIGLIE PER IL TRASPORTO. SUPPORTO POSTERIORE 3D STAMPATO IN EVA E NYLON, CON APERTURA A TUTTA LUNGHEZZA. 12 TASCHE OLTRE ALLO SCOMPARTO PRINCIPALE. TASCA ESTERNA PER DOCUMENTI, VANO PER LE SCARPE. FERMO ELASTICO

*BAG/BACKPACK WITH SHOULDER STRAPS CONVERTIBLE INTO CARRYING HANDLES. PRINTED BACK SUPPORT MADE OF EVA AND NYLON, WITH FULL-LENGTH OPENING. 12 POCKETS IN ADDITION TO THE MAIN COMPARTMENT. EXTERNAL POCKET FOR DOCUMENTS, SHOE COMPARTMENT. ELASTICATED RETAINER.*

ADJUSTABLE FOAM PADDED SHOULDERS  
HELMET POCKET  
FOAM PADDED SKI BOOT POCKET  
MAIN POCKET  
2 POCKETS ON BOTH SIDES

CAPACITÀ / CAPACITY: 40LT  
TESSUTO / FABRICS: POLYESTER  
PESO / WEIGHT: 1000 GR



Helmet Pocket



## WAIST BAG WATER BLADDER COD. 52085

COD. 52085

MARSUPIO BORRACCIA ISOLATA TERMICAMENTE CON DIVERSE TASCHE PER ALLOGGIAMENTO ACCESSORI.  
THERMAL WAIST POUCH FLASK HOLDER WITH VARIOUS POCKETS FOR STORING ACCESSORIES.

CAPACITÀ / CAPACITY: 1LT  
TESSUTO / FABRICS: POLYESTER  
PESO / WEIGHT: 200 GR

WATER BLADDER  
KEY POCKET  
FOOD POCKET  
ELASTIC MESH MAIN POCKET  
SILICONE PRINT  
POLE HOLSTER



## SKI COVER 164/178 cod. 52090

### FEATURES

Size: 164/178 - 192 and 205 cm



## ATTIVO SKI BAG cod. 52088

### FEATURES

Portasci regolabile *Adjustable ski bag.*  
Size: 171 - 186 - 205 cm



## GARA SKI TROLLEY BAG cod. 52080

### FEATURES

Capiente borsa portasci con trolley.  
*Large ski trolley bag.*  
Size: 205 cm



## ATTIVO SKI BOOT BAG cod. 52089

### FEATURES

Borsa scarponi con tasca esterna, piano appoggio rigido.  
*Ski boot bag with external pocket, stiff bottom.*



## EVO SKI BOOT BAG cod. 52086

### FEATURES

Borsa scarponi con tasca esterna, piano appoggio rigido.  
*Ski boot bag with external pocket, stiff bottom.*



## NECK WARMER

**Cod. 52057**

FEATURES  
Polypropylene



## THERMO WAIST BAG cod. 52071

### FEATURES

Borraccia isolata termicamente.  
Tasca portaoggetti, cintura comfort.  
*Thermal flask, coin pocket, comfort belt.*



## XC SEPARATOR

**Cod. PR14SEP**



## SKI STRAP 15 mm

**Cod. PR14LAC**



## SKI STRAP 40 mm

**Cod. PR14LAC2**



## ELASTIC SKI STRAP

**Cod. PR17LAC\_ALP**

## SKI STRAP PRO Cod. 52087

SIZE: 40/50/60 cm



## EVO SNOW PROBE Cod. 31024



### FEATURES

SIZE  $\Phi$ 60/74 cm  
Misura pala / Blade size: 24.5 x 28.5 cm  
Peso / Weight: 520 gr.

## GARA.2 SNOW SHOVEL Cod. 31023



### FEATURES

SIZE  $\Phi$ 50 cm  
Misura pala / Blade size: 20x20 cm  
Peso / Weight: 282 gr.

## EVO SNOW SHOVEL Cod. 31025



**TELO TERMICO  
THERMIC BLANKET**  
Cod. 33004



**KIT PRONTO SOCCORSO  
FIRST AID KIT**  
Cod. 33001

## BEANIES / BANDS



## WOOL TECH BEANIE

COD. 85159

INNOVATIVO BERRETTO CON NUOVA TECNOLOGIA SKI TRAB WOOL TECH, LEGGERO, CALDO E TRASPIRANTE

INNOVATIVE BEANIE USING THE NEW SKI TRAB WOOL TECH TECHNOLOGY, LIGHTWEIGHT, WARM AND BREATHABLE.

Material: 40% wool - 39% polypropylene - 21% polyamide

Available in 3 different colours



Colore / Colour:

- 01
- 02
- 03

# WOOL TECH WARMER

COD. 85162

INNOVATIVO SCALDACOLLO CON NUOVA TECNOLOGIA SKI TRAB WOOL TECH, LEGGERO, CALDO E TRASPIRANTE  
INNOVATIVE NECK WARMER USING THE NEW SKI TRAB WOOL TECH TECHNOLOGY, LIGHTWEIGHT, WARM AND BREATHABLE.

Material: 40% wool - 39% polypropylene - 21% polyamide  
Available in 3 different colours



e / Colour:  
○ 01  
● 02  
● 03

# WOOL TECH BAND

COD. 85160

INNOVATIVA FASCIA CON NUOVA TECNOLOGIA SKI TRAB WOOL TECH, LEGGERA, CALDA E TRASPIRANTE  
INNOVATIVE HEADBAND USING THE NEW SKI TRAB WOOL TECH TECHNOLOGY, LIGHTWEIGHT, WARM AND BREATHABLE.

Material: 40% wool - 39% polypropylene - 21% polyamide  
Available in 3 different colours



Colore / Colour:  
○ 01  
● 02  
● 03



## BEANIE GARA HIGH MOUNTAIN

COD. 85172

BERRETTO IN LYCRA FODERATO IN CALDO PILE PER GARANTIRE UN'OTTIMA TERMICITÀ  
*LYCRA BEANIE WITH FLEECE LINING TO GUARANTEE EXTRA WARMTH.*

Material: 82% Polyamide - 18% Elastane



## BEANIE GARA GRAN COURSE

COD. 85173

CAPPELLINO CON CARATTERISTICI COLORI SKI TRAB CON GRAFICA TRANSFER 3D E CON INTERNO 3D FLEECE - I COLORI SONO PARTICOLARMENTE BRILLANTI  
*BEANIE IN SIGNATURE SKI TRAB COLOURS WITH 3D TRANSFER GRAPHICS AND 3D FLEECE LINING - EXTRA BRIGHT COLOURS*

Material: 50% Polyamide - 39% Polyester - 11% Elastane



Colore / Colour:

- 01
- 02

## BAND GARA HIGH MOUNTAIN

COD. 85176

FASCIA IN LYCRA CON INTERNO DOPPIO STRATO IN PILE, MOLTO CALDA  
*LYCRA HEADBAND WITH DOUBLE LAYER FLEECE LINING, VERY WARM*

Material: 82% Polyester - 18% Elastane



## BAND GARA GRAN COURSE

COD. 85174

FASCIA CON CARATTERISTICI COLORI SKI TRAB CON GRAFICA TRANSFER 3D E CON INTERNO 3D FLEECE - I COLORI SONO PARTICOLARMENTE BRILLANTI  
*HEADBAND IN CLASSIC SKI TRAB COLOURS WITH 3D GRAPHIC TRANSFER AND 3D FLEECE LINING - EXTRA BRIGHT COLOURS*

Material: 50% Polyamide - 39% Polyester - 11% Elastane

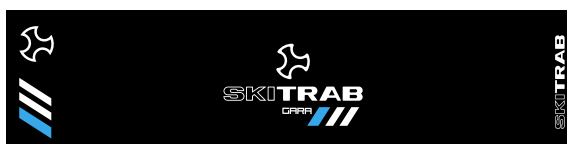

Colore / Colour:

- 01
- 02

## BEANIE GARA COD. 85171

CAPPELLINO CON CARATTERISTICI COLORI SKI TRAB CON STAMPA SUBLIMATA - I COLORI SONO PARTICOLARMENTE BRILLANTI - IN LYCRA CON INTERNO IN LIGHT PILE - PERFETTO ANCHE DA UTILIZZARE COME SOTTOCASCO.

*INNOVATIVE BEANIE IN SIGNATURE SKI TRAB COLOURS WITH SUBLIMATED PRINT. THE COLOURS ARE PARTICULARLY BRIGHT. MADE OF LYCRA WITH A LIGHT FLEECE LINING. PERFECT TO WEAR UNDER THE HELMET*

Material: 80% Polyester - 20% Elastane



## BAND GARA COD. 85175

FASCIA CON CARATTERISTICI COLORI SKI TRAB CON STAMPA SUBLIMATA - I COLORI SONO PARTICOLARMENTE BRILLANTI - IN LYCRA CON INTERNO IN LIGHT PILE - PERFETTA ANCHE DA UTILIZZARE COME SOTTOCASCO.

*HEADBAND IN SIGNATURE SKI TRAB COLOURS WITH SUBLIMATED PRINT. THE COLOURS ARE PARTICULARLY BRIGHT. MADE OF LYCRA WITH A LIGHT FLEECE LINING. PERFECT TO WEAR UNDER THE HELMET.*

Material: 80% Polyester - 20% Elastane



Colore / Colour:

- 01
- 02

Colore / Colour:

- 01
- 02

## BEANIE BRAND COD. 85168

CAPPUCCIA IN LANA CON LAVORAZIONE JAQUARD CON LOGO SKI TRAB CON COLORI A CONTRASTO.

WOOL BEANIE WITH JACQUARD PATTERN AND SKI TRAB LOGO IN CONTRASTING COLOURS.

Material: 50% wool - 50% Acrylic



Colore / Colour:

- 01
- 02
- 03

## BAND BRAND COD. 85169

FASCIA ALTA IN LANA CON LAVORAZIONE JAQUARD CON INTERNO IN PILE - SCRITTA GRANDE SKI TRAB CON COLORI A CONTRASTO

WOOL HEADBAND WITH JACQUARD PATTERN AND FLEECE LINING - LARGE SKI TRAB LOGO IN CONTRASTING COLOURS

Material: 50% wool - 50% Acrylic



Colore / Colour:

- 01
- 02
- 03

## BEANIE SUPERMAXIMO 3.0

COD. 85166

BERRETTO IN LANA CON PUNTO A GRANA DI RISI - INTERNO IN PILE PER GARANTIRE UN' OTTIMA TERMICITÀ  
MOSS STITCH WOOL BEANIE WITH FLEECE LINING TO GUARANTEE EXTRA WARMTH

Material: 50% wool - 50% Acrylic  
Inner: 100% Polyester



Colore / Colour:

- 01
- 02
- 03
- 04

## BAND SUPERMAXIMO 3.0

COD. 85167

FASCIA IN LANA CON PUNTO A GRANA DI RISI - INTERNO IN PILE PER GARANTIRE UN' OTTIMA TERMICITÀ  
MOSS STITCH WOOL HEADBAND WITH FLEECE LINING TO GUARANTEE EXTRA WARMTH

Material: 50% wool - 50% Acrylic  
Inner: 100% Polyester



Colore / Colour:

- 01
- 02
- 03
- 04

## BEANIE ORTLES COD. 85163

BERRETTO IN LANA CON LAVORAZIONE LANA A COSTE LARGHE E CON INTERNO IN PILE CON COLORI A CONTRASTO  
*RIBBED WOOL BEANIE WITH FLEECE LINING AND CONTRASTING COLOURS.*

Material: 50% wool - 50% Acrylic  
Inner: 100% Polyester

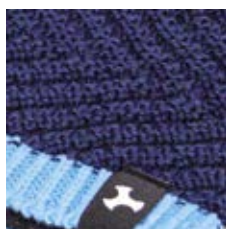

Colore / Colour:  
● 01 Petrol  
● 02 Blue  
● 03 Blue Night  
○ 04 White

## BAND ORTLES COD. 85164

FASCIA IN LANA CON LAVORAZIONE LANA A COSTE LARGHE E CON INTERNO IN PILE CON COLORI A CONTRASTO  
*RIBBED WOOL HEADBAND WITH FLEECE LINING AND CONTRASTING COLOURS*

Material: 50% wool - 50% Acrylic  
Inner: 100% Polyester

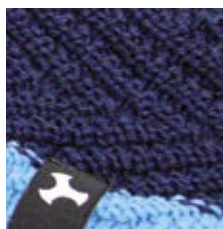

Colore / Colour:  
● 01 Petrol  
● 02 Blue  
● 03 Blue Night  
○ 04 White

## BEANIE VARIO 2 COD. 85170

CAPPELLINO IN LANA MONOCOLORE  
MONOCHROME WOOL BEANIE

Material: 50% wool - 50% Acrylic



Colore / Colour:

- 01
- 02
- 03
- 04

## HAT SKI TRAB cod. PR - A01



## CLOTHES

### T-SHIRT BRAND

MAN cod. PR - A02 / WOMAN cod. PR - A02W



### T-SHIRT NEVE BRAND

MAN cod. PR - A02N / WOMAN cod. PR - A02WN



## HAT SKI TRAB NEVE cod. PR - A01N





## GARA TRACK SUIT M cod. 84185

## GARA TRACK SUIT W cod. 84186

TUTA INTERA DA SCIALPINISMO IN LYCRA MERYL E RINFORZI IN CORDURA STRETCH, ZIP YKK, ZIP DIAGONALE ERGONOMICA. TASCHE SIA INTERNE CHE ESTERNE PER RIPORRE MATERIALE O TESSILFOCA. TASCINA INTERNA PER ARTVA CON ZIP.

*ONE-PIECE RACING SUIT DESIGNED FOR SKI MOUNTAINEERING MADE OF LYCRA MERYL WITH CORDURA STRETCH REINFORCEMENTS, YKK ZIP, ERGONOMIC DIAGONAL ZIP. INTERNAL AND EXTERNAL POCKETS TO STASH MATERIAL OR CLIMBING SKINS. INTERNAL ZIPPED POCKET FOR AVALANCHE BEACON.*

**Material:** Schoeller® ITD ProTec: blend of Carbon yarns and ceramic prints provides a fabric with very high abrasion resistance, especially in the case of high speed crashes.

Lycra, Meryl, cordura stretch, ykk zip

MEN'S SIZE: S - M - L - XL-XXL

WOMEN'S SIZE: XS - S - M

## GARA TRACK SUIT M 2Pcs cod. 84187

## GARA TRACK SUIT W 2Pcs cod. 84188

### PANTALONE/PANTS cod. 84189

TUTA DUE PEZZI DA SCIALPINISMO IN LYCRA MERYL E RINFORZI IN CORDURA STRETCH, ZIP YKK, ZIP DIAGONALE ERGONOMICA. TASCHE SIA INTERNE CHE ESTERNE PER RIPORRE MATERIALE O TESSILFOCA. TASCINA INTERNA PER ARTVA CON ZIP.

*TWO-PIECE SUIT DESIGNED FOR SKI MOUNTAINEERING MADE OF LYCRA MERYL WITH CORDURA STRETCH REINFORCEMENTS, YKK ZIP, ERGONOMIC DIAGONAL ZIP. INTERNAL AND EXTERNAL POCKETS TO STASH MATERIAL OR CLIMBING SKINS. INTERNAL ZIPPED POCKET FOR AVALANCHE BEACON.*

**Material:** Schoeller® ITD ProTec: blend of Carbon yarns and ceramic prints provides a fabric with very high abrasion resistance, especially in the case of high speed crashes.

Lycra, Meryl, cordura stretch, ykk zip

MEN'S SIZE: S - M - L - XL-XXL

WOMEN'S SIZE: XS - S - M

PANT'S SIZE: XS-S-M-L-XL-XXL

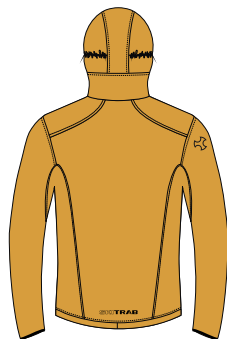

## STELVIO JACKET - cod. 84192

Realizzata in un nuovo materiale leggero e riciclato. Il taglio anatomico e il materiale elasticizzato utilizzato garantiscono il massimo comfort durante qualsiasi attività all'aperto. Il materiale molto leggero, funzionale e resistente all'abrasione offre una protezione perfetta dal vento ed è molto traspirante. La giacca è la scelta ideale non solo per alpinisti e scialpinisti, ma anche per gli appassionati di outdoor.

Made of a new lightweight and recycled material. The anatomically designed cut and stretch material used guarantees the maximum comfort during any outdoor activity. The very light, functional and abrasion-resistant material provides perfect protection against wind and is very breathable. The jacket is an ideal choice not only for climbers and mountain skiers, but also for other outdoor enthusiasts.

**Colour:** mango/anthracite  
**Weight:** 278 g  
**Material:** Main: 89 % Polyamide (Recycled Nylon) + 11 % Polyurethane (Spandex), DWR  
 4 way stretch lightweight fabric  
**Cut men:** (REGULAR FIT)

**Sizes:** S-M-L-XL-XXL



## STELVIO PANT COD. 84194

Pantaloni funzionali dal taglio altamente tecnico, sviluppati per lo scialpinismo, backcountry, spedizioni di un giorno, arrampicata su ghiaccio e arrampicata mista, nonché per lo sci di fondo ricreativo. Dettagli tecnici, scelta dei materiali e taglio hanno tutto ciò che richiedi per gli sport invernali. Il taglio anatomico perfetto deriva dalla forma naturale del corpo umano e ne accompagna il movimento durante lo sport. Questi pantaloni si adattano perfettamente e offrono il massimo comfort.

Functional pants with a highly technical cut, specially developed for ski touring, backcountry, one-day expeditions, ice climbing and mixed climbing, as well as recreational cross-country skiing. Technical details, choice of materials and cut – we've tailored everything to what you demand from winter sports equipment. The perfect anatomical cut is derived from the natural shape of the human body and copies its movement during sport. These pants 'sit' perfectly and provide maximum comfort.

**Colour:** Black/mango  
**Material Main:** 1: 45 % Polyamide (Nylon) + 23 % Polyamide (Cordura®) + 23 % Polyester (Thermolite®) + 9 % Polyurethane, DWR - Abrasion resistant brushed fabric, Main 2: 85 % Polyamide (Nylon) + 15 % Polyurethane (Spandex), DWR - Rip-stop stretch fabric, Support: 8  
**Cut men:** (REGULAR FIT)

**Sizes:** S-M-L-XL-XXL





## ORTLES JACKET - cod. 84196

La giacca si caratterizza per la sua leggerezza e compattezza. Il nostro materiale esterno Pertex Quantum Air, estremamente leggero è completato dal materiale traspirante ed elastico delle maniche e dei fianchi. Isolamento in Polartec Alpha, moderno elastico ed estremamente traspirante concorre alla riduzione del peso. Il taglio anatomico combinato con i materiali tecnici la rende una giacca ben isolata specifica per le attività aerobiche. Grazie alla eccellente resistenza al vento fornisce protezione nelle condizioni avverse minimizzando al perdita di calore. Una giacca comoda e traspirante, la migliore scelta per lo scialpinismo.

The jacket is characterized by its lightness and great packability. Our outer material, extremely lightweight Pertex Quantum Air complemented by breathable stretch material on sides and sleeves. Modern stretch and highly breathable Alpha Polartec insulation, unlined to reduce weight. The anatomical cut combined with the technical materials make it a great reserve insulation jacket especially suitable for aerobic activities. Due to its excellent wind resistance, it provides protection in adverse weather conditions, minimizing the loss of body temperature. A breathable, comfortable jacket – the obvious choice for ski mountaineering.

**Colour:** mango/anthracite

**Weight:** 368 g

**Material Main:** 100 % Polyamide (Nylon), DWR - PERTEX® Quantum Air; Insulation: 100% Polyester - POLARTEC® ALPHA; Support: 89 % Polyamide + 11 % Polyurethane (Spandex), DWR - 4 way stretch lightweight fabric;

**Cut men:** (ATHLETIC FIT)

**Sizes:** S-M-L-XL-XXL

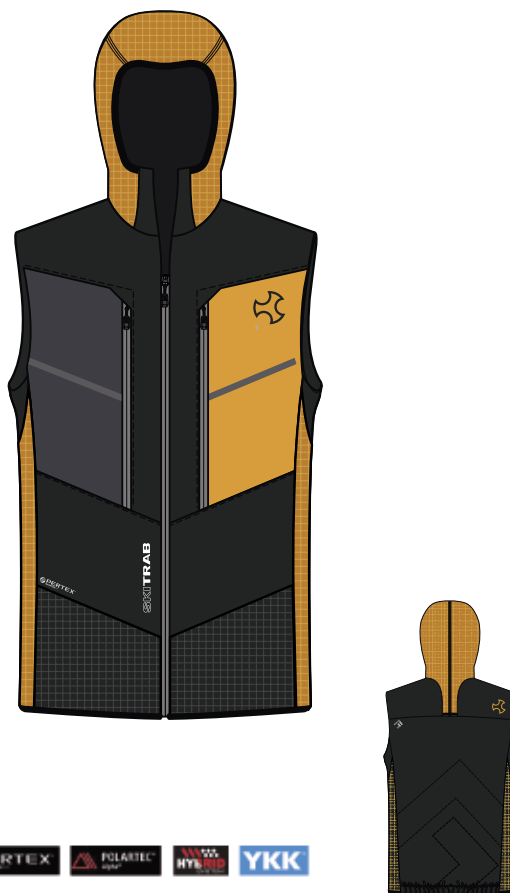

## ORTLES VEST - cod. 84197

Un gilet con polartech Alpha leggero, comprimibile e caldo in una versione migliorata. Il materiale esterno Pertex Quantum Air è completato dal pile Technostretch® Grid sui pannelli laterali, che aumenta il comfort durante le attività sportive con la sua elasticità e traspirabilità. Moderno isolamento Polartec Alpha senza fodera per un peso ridotto e ancora più traspirabilità. Una combinazione di taglio anatomico e materiale tecnico crea un isolamento leggero particolarmente adatto per le attività aerobiche. Grazie alla sua eccellente resistenza al vento, fornisce protezione in condizioni climatiche avverse. Un gilet che i clienti non dovrebbero perdere in nessuna scalata in montagna, sci alpinismo o escursione.

A lightweight, packable and warm Alpha vest in an upgraded version. The outer material Pertex Quantum Air is complemented by Technostretch® Grid fleece on side panels, which increases the comfort of athletic activities with its elasticity and offers very high breathability. Modern Polartec Alpha insulation without lining for reduced weight and even more breathability. A combination of the anatomical cut and technical material creates a comfortable lightweight insulation particularly suitable for aerobic activities. Due to its excellent wind resistance, it provides protection in adverse weather conditions. A vest that customers shouldn't miss on any mountain climb, ski tour or hike.

**Colour:** mango/anthracite

**Weight:** 230 g

**Material Main:** 100 % Polyamide (Nylon), DWR - PERTEX® Quantum Air;

**Isulation:** 100% Recycled Polyester - POLARTEC® ALPHA;

Support 1: 91

% Polyester + 9 % Polyurethane (Elastane)

Technostretch® Grid fleece;

Support 2: 89 % Polyamide + 11 % Polyurethane (Spandex),

DWR - 4 way stretch lightweight fabric;

**Cut men:** (ATHLETIC FIT)

**Sizes:** S-M-L-XL-XXL

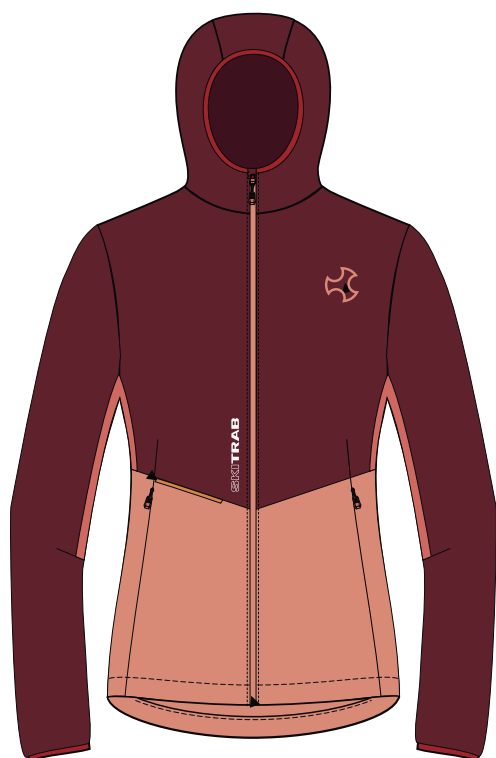

## GAVIA JACKET - cod. 84193

La giacca Sofshell ultraleggera realizzata in materiale traspirante e riciclato è progettata per un'ampia gamma di attività sportive in montagna. Il taglio anatomico e il materiale elasticizzato garantiscono il massimo comfort durante tutte le attività all'aperto per l'utente. Grazie alla sua traspirabilità e al materiale leggero sui lati, questa giacca traspira molto bene. Lo apprezzerai per le attività sportive aerobiche, in particolare per lo scialpinismo.

The ultralight Sofshell jacket made of breathable and recycled material is designed for a wide range of sports activities in the mountains or the valleys. The anatomically designed cut and stretch material guarantee maximum comfort during all outdoor activities for the user. Thanks to its breathability and lightweight material on sides, this "windbreaker" breathes very well. You will appreciate it for aerobic sports activities, especially for ski touring.

**Colour:** palisander/coral

**Weight:** 219 g

**Material Main:** 89 % Polyamide (Recycled Nylon) + 11 % Polyurethane (Spandex), DWR - 4 way stretch lightweight fabric

**Cut lady:** (REGULAR FIT)

**SIZE Women:** XS - S - M - L



## GAVIA PANT COD. 84195

Pantaloni tecnici da donna sviluppati per spedizioni di sci alpinismo, arrampicata su ghiaccio e misto, sci di fondo ricreativo ed escursionismo. Il taglio anatomico imita la forma naturale del corpo di una donna, muovendosi senza sforzo con te. I pantaloni si adattano perfettamente e offrono il massimo comfort. L'elastico in vita garantisce una vestibilità molto confortevole. Tasche e prese d'aria sono posizionate in modo da poterle raggiungere anche durante una salita difficile indossando un'imbracatura.

Women's technical pants developed for ski touring expeditions, ice and mixed climbing, as well as recreational cross-country skiing and hiking treks. The anatomical cut mimics the natural shape of a woman's body, moving effortlessly with you. The pants fit perfectly and provide maximum comfort. The elastic waistband guarantees a very comfortable wear. Pockets and vents are positioned so that you can reach into them even during a difficult climb while wearing a harness.

**Colour:** anthracite/coral

**Weight:** 355 g

**Material Main:** 1: 45 % Polyamide (Nylon) + 23 % Polyamide (Cordura®) + 23 % Polyester (Thermolite®) + 9 % Polyurethane, DWR - Abrasion resistant brushed fabric, Main 2: 42 % Polyamide (Cordura®) + 29 % Polyamide (Nylon) + 17 % Polyester (Aerocool) + 12 % Polyuret

**Cut lady:** (REGULAR FIT)

**SIZE Women:** XS - S - M - L



## GARA AERO JACKET 2.1 COD. 84190

GIACCA IMPERMEABILE IN NYLON WATERPROOF RICHIUDIBILE IN UNA PICCOLA E COMPATTA TASCA. CUCITURE TERMONASTRATE.

WATERPROOF PACKABLE JACKET MADE OF NYLON THAT FOLDS INTO A SMALL, COMPACT POCKET. HEAT-TAPED SEAMS.

## GARA AERO PANT 2.1 COD. 84191

PANTALONE IMPERMEABILE IN NYLON CON ZIP LATERALI. CUCITURE TERMONASTRATE. WATERPROOF NYLON PANTS WITH LATERAL ZIPS. HEAT-TAPED SEAMS.

Material: 100% NYLON - WP: 15.000 - MVTR: 15.000  
SIZE: XS - S - M - L - XL - XXL

## SOCKS ALPIK

COD. 84154 long- COD. 84155 short

La costruzione in maglia rasata ed elasticizzata sul gambale e piede ne favorisce la massima precisione di calzata e un anti-rollio dinamico.

Le parti del piede di maggior contatto e frizione come, punta, tallone, collo del piede e tendine d'achille sono realizzate in morbida spugna di Merino, seta e Polipropilene che garantiscono massimo confort, buona azione anti-vesciche e favoriscono un microclima ideale per il benessere generale. Leggera, resistente e grazie al accoppiata della lana Merino e seta con il Polipropilene, è molto coibente traspirante e facile da lavare a 30° come tutti i capi tecnici.

*Knitted in stockinette stitch, with elasticised leg and foot, offering a precise fit. They don't roll down your leg at all. The parts of the foot with greater contact and friction like toes, heel, instep and Achilles tendon are made of a soft Merino wool, silk and polypropylene blend that guarantees maximum comfort, protection from blisters providing an ideal microclimate for general well-being. Lightweight, resistant and, thanks to the blending of merino wool and silk with polypropylene, insulating, breathable and easy to wash at 30° like all technical sportswear.*

Material: 70% Merinos Wool - 20% Silk - 8% Poliammide - 2% Elastan  
SIZE: 35/37 - 38/42 - 41/43 - 44/46



## SOCKS ALPIK RACE 1 SILK

COD. 84184

Material: 70% Merinos Wool - 20% Silk - 8% Poliammide - 2% Elastan  
SIZE: 35/37 - 38/42 - 41/43 - 44/46

**DOWN JACKET BORMIO MAN**  
 COD. 84175  
**DOWN JACKET BORMIO WOMAN**  
 COD. 84176



**FEATURES**

Shell: 100 % polyester  
 Lining: 100 % nylon  
 Inner padding: white duck feather - 10 % - down feather 20 %  
 WP (Waterproofing): Black Fabric (top) 10.000 WP  
 MVTR (Moisture vapour transmission rate): 10.000  
 Grey fabric: no WP no MVTR  
 Stitch-free baffling for zero drafts  
 MEN'S SIZE: S - M - L - XL - XXL  
 WOMEN'S SIZE: XS - S - M - L

**FLEECE BORMIO MAN** COD. 84177  
**FLEECE BORMIO WOMAN** COD. 84178

FLEECE IN POLYESTERE E SPANDEX VERSIONE UOMO E DONNA.  
 MEN'S AND WOMEN'S POLYESTER AND SPANDEX FLEECE.



Colore / Colour:  
 ● 01 - ● 02 - ● 03 MAN  
 ● WOMAN



Material: 90% Polyester, 10% Spandex, breathable insulating dynamic fabric.  
 MEN'S SIZE: S - M - L - XL - XXL - XXXL  
 WOMEN'S SIZE: XS - S - M - L

## SKI+TITAN BINDING DISPLAY

cod PRDEMOSKI



## DEMO KEY

cod. PRK-40279

## BINDING WOOD DISPLAY

cod PRPW-40279 TITAN VARIO.2

cod PRPW-40301 TR1

(with demo titan key and graphics - without binding)



## BINDING DISPLAY

cod. PRP-40237 Titan Gara

cod. PRP-40279 Titan Vario.2

cod. PRP-40301 TR1



## PENNONE A VELA / SAILFLAG

cod PR-F01

Size/misura: 500 cm x 80 cm

Bandiera in tessuto nautico, struttura interamente in alluminio, gancio di sicurezza per fissare la tenda, borsa per il trasporto con massima resistenza.

*Flag made of nautical fabrics, 100% aluminium frame safety hook to fix the flag, highly resistant bag.*

## BANNER

cod PR11BA

altezza 80cm - height 80cm - (a metro)



## SKI MONO DISPLAY

cod. PR-SKI



## NORDIC SKI

cod PR-CAT1

CATALOGO CATALOGUE  
misura/size 20 cm x 20 cm



## TOURING SKI

cod PR-CAT2

CATALOGO CATALOGUE  
misura/size 20 cm x 20 cm

## FLAG EASY

cod. PR-F02

size/misura: 200 cm  
Bandiera in tessuto nautico,  
borsa per il trasporto con  
massima resistenza.  
*Flag made of nautical fabrics, highly  
resistant bag.*



## BROCHURE

cod PR-CAT3

CATALOGO CATALOGUE  
misura/size 20 cm x 20 cm

## FLYER DISPLAY

cod PR-CAT4

CATALOGO CATALOGUE  
misura/size 20 cm x 20 cm

## DISTRIBUTORS 2022/23

---

### AUSTRIA-GERMANY

#### UHL GÜNTER

Exklusiv Sportartikelvertrieb GmbH  
Wieselsdorfer Straße 34 - 8504 Prading  
Tel. +43 31852286 - Fax +43 3185228633 - guenter.uhl@aon.at

### BULGARIA

#### NAMASTE LTD BORISLAV DIMITROV

26 b, Arch. Milanov - Sofia  
Tel. +35 928669367 - info@namaste-bg.com

### CHINA

#### FUSHUN SNOW YU AN SPORT CULTURE CO. LTD

HUA DA STREET 1-1/1412 - Shun Chen District  
Liaoning Province Fushun City  
Tel. +86 13252866353 - 251231779@qq.com

### FRANCE

#### NIC-IMPEX SPORTS & OUTDOOR EQUIPMENT

8 rue de bouvieres, Pae des Glaisins - 74940 Annecy Le Vieux  
Tel +33 450 571351 - Fax +33 450 677795 - info@nic-impex.com

### NORWAY

#### KÅRVATN HANDELSKOMPANI AS

Karvatn Gard - 6645 Todalen - Tel: +47 979 56 775  
gudmund@karvatn.com - www.karvatn.com

### SPAIN-ANDORRA

#### ARTIDA SPORT S.L.

Calle Muntaner 335 PRL 1R - 08190 Barcelona  
Tel. +34 934 143423 - Fax +34 934 146421 - info@artida.es

### SOUTH KOREA

#### HIMAZONE

6-19 Gyeongchun-ro - 227beon-gil Guri-si Gyeonggi-do - Korea 11926  
Tel +82 31 566 2336 - Fax +82 31 566 2320 - kish@kotis.net

### ROMANIA

#### S.C. OUTDOOR EMOTION S.R.L.

Romania, Baia Mare, Victoriei Street, No.3  
Tel. +40 722771267 - conceptfly@yahoo.com

### RUSSIA

#### EXPONENTA LTD

141014 Mytischki box 480 - Tel/fax +7 498 610 31 21  
exponenta@inbox.ru - skislava@gmail.com - www.snowshoes.ru

### UNITED KINGDOM

#### GAUSEN&CO LTD

34 Glenilla Rd, London, NW3 4AN  
Tel.+44 7769 88 747 - Admin@Gausenco.com

## AGENTS 2022/23 WORLDWIDE

---

### CZECHIA-SLOVAKIA-POLAND

#### JOSEF SIMUNEK

Heydukova 1589/6 - 18000 Praha 8  
Tel. +420 604 269045 - josef.simunek@himalaya8000.com

### SWITZERLAND

#### ANCHIERI DAVIDE

Tel. +41 79 158 34 36  
Tel. +39 340 555 12 03 - d.anchieri@skitrab.com

### USA/CANADA

#### VARALDI VINCENT

27 Chemin des étoiles - Eastman JOE 1P0 QC Canada  
Tel. +1 819 578 4345 - email: vincent.varaldi@gmail.com

### AUSTRALIA-NEW ZELAND

#### HUGH NEWALL

Suite 11/7 Beissel St, Belconnen ACT, Australia, 2617  
Tel. +61 432 687 399 - hugh.newall@bokhara-projects.com.au

## AGENTS 2022/23 ITALY

---

### LOMBARDIA-PIEMONTE-VALLE D'AOSTA-LIGURIA

#### SKI TRAB SRL

Via Battaglione Tirano, 6 - 23032 Bormio (SO)  
Tel. +39 0342 901650 - Fax +39 0342 905178  
info@skitrab.com

### ALTO ADIGE-VAL DI Fiemme-VAL DI FASSA

#### MAURO MADDALOZZO

Mob. 328 0305524 - Fax +39 0439 59106  
madservice.ski@gmail.com

### TRENTINO-VENETO-FRIULI

#### MAURIZIO GIORDANI

Tel./Fax +39 0464 490525  
Cell. +39 335 6755191 - info@gmountain.it

### EMILIA ROMAGNA

#### LUIGI TABANELLI

Tel. +39 051 6511174 - Fax +39 051 4682776  
Cell. +39 335 5412013 - luigitabanellibo@gmail.com

### LAZIO-UMBRIA-MOLISE-ABRUZZO-MARCHE

#### CONCETTA DI BIASE

Tel./Fax 0862.917547 - Cell. 339.4468646  
pierodibiase@alice.it



**MADE IN BORMIO SINCE 1946**  
**COLLECTION 2023/2024**



SKITRAB.COM

**SKITRAB**

**SKI TRAB SRL**

Via Alu' 39 - 23030 Bormio/Valdisotto (SO)

[www.skitrab.com](http://www.skitrab.com) - [info@skitrab.com](mailto:info@skitrab.com)

 SKI TRAB

 skitrab\_srl